

# Installation Manual

## NetBotz<sup>®</sup> Rack Sensor Pod 150

NBPD0150

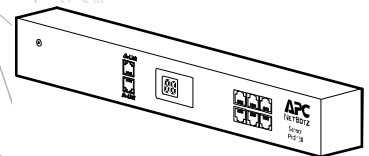



---

This manual is available in English on the enclosed CD.

Dieses Handbuch ist in Deutsch auf der beiliegenden CD-ROM verfügbar.

Este manual está disponible en español en el CD-ROM adjunto.

Ce manuel est disponible en français sur le CD-ROM ci-inclus.

Questo manuale è disponibile in italiano nel CD-ROM allegato.

本マニュアルの日本語版は同梱の CD-ROM からご覧になれます。

Instrukcja Obsługi w języku polskim jest dostępna na CD.

O manual em Português está disponível no CD-ROM em anexo.

Данное руководство на русском языке имеется на прилагаемом компакт-диске.

您可以从包含的 CD 上获得本手册的中文版本。

동봉된 CD 안에 한국어 매뉴얼이 있습니다 .

# Contents

---

- Introduction . . . . . 1**
  - Product description . . . . . 1
  - Document overview . . . . . 1
  - Additional documentation . . . . . 1
  - Additional options . . . . . 2
  - InfraStruXure-certified . . . . . 2
  
- Physical Description. . . . . 3**
  - Rear . . . . . 3
  - Front . . . . . 3
  
- Inventory . . . . . 4**
  
- Install the NetBotz 150 . . . . . 5**
  - Toolless peg-mount installation . . . . . 5
  - Rack-mount installation . . . . . 6
  
- Connect Sensors. . . . . 7**
  
- Configure and Monitor Sensors . . . . . 7**
  
- Upgrade the NetBotz 150 . . . . . 7**
  
- Clean the NetBotz 150 . . . . . 7**
  
- Specifications . . . . . 8**
  
- Two-Year Factory Warranty . . . . . 9**
  - Terms of warranty . . . . . 9
  - Non-transferable warranty . . . . . 9
  - Exclusions . . . . . 9
  - Warranty claims . . . . . 10
  - Obtaining service . . . . . 10



# Introduction

## Product description

The American Power Conversion (APC<sup>®</sup>) NetBotz Rack Sensor Pod 150 connects to a NetBotz appliance and allows you to increase the space monitored by your NetBotz security and environmental monitoring system. You can connect the NetBotz 150 to one of the following appliances: NetBotz Rack Monitor 200 (NBRK0200), NetBotz Rack Monitor 450 (NBRK0450), NetBotz Room Monitor 455 (NBWL0455), or NetBotz Rack Monitor 550 (NBRK0550). The Rack Sensor Pod 150 cannot be used with a NetBotz Room Monitor 355.

The NetBotz 150 includes six sensor ports for monitoring input from APC environmental sensors and other third-party sensors. The total number of NetBotz 150s that you can use and the types of sensors that can be used with the NetBotz 150 depends upon the specific appliance to which the NetBotz 150 is connected. For details, see the installation and quick configuration manual included with your appliance.

## Document overview

The *NetBotz Rack Sensor Pod 150 Installation Manual* describes how to install the NetBotz 150. For details on connecting the NetBotz 150 to your appliance, see the installation and quick configuration manual included with your appliance.

## Additional documentation

Unless otherwise noted, the following documentation is available on the CD provided with the device or on the applicable product page on the APC Web site, [www.apc.com](http://www.apc.com). To quickly find a product page, enter the product name or part number in the Search field.

***NetBotz Appliance User's Guide*** – Includes all details for using, managing, and configuring a NetBotz system with one of the following appliances: NetBotz Room Monitor 355 (NBWL0355, NBWL0356), NetBotz Rack Monitor 450 (NBRK0450), NetBotz Room Monitor 455 (NBWL0455, NBWL0456), or NetBotz Rack Monitor 550 (NBRK0550).

***NetBotz Rack Monitor 200 User's Guide*** – Includes all details for using, managing, and configuring the system when using a NetBotz Rack Monitor 200 (NBRK0200).

## Additional options

The following options are available for the NetBotz 150. Some options may not be supported by each rack or room monitor to which the NetBotz 150 can be connected. See the options listed in the installation instructions included with your rack or room monitor. For more information about any of the options, contact your APC representative or the distributor from whom you purchased your APC product.

- Temperature Sensor (AP9335T)
- Temperature/Humidity Sensor (AP9335TH)
- NetBotz Spot Fluid Sensor (NBES0301)
- NetBotz Smoke Sensor (NBES0307)
- NetBotz Vibration Sensor (NBES0306)
- NetBotz Door Switch Sensor for APC Racks (NBES0303)
- NetBotz Door Switch Sensor for Rooms or Third Party Racks (NBES0302)
- NetBotz Dry Contact Cable (NBES0304)
- NetBotz 0-5 V Sensor Cable (NBES0305)
- Power Supply 100-230 VAC/24 VDC (AP9505i)

## InfraStruXure-certified

This product is certified for use in APC InfraStruXure<sup>®</sup> systems.

# Physical Description

## Rear

Toolless mounting pegs allow for installation in APC NetShelter<sup>®</sup> VX and SX racks and enclosures without using any U-spaces. (For more details, see “Toolless peg-mount installation” on page 5.)

## Front

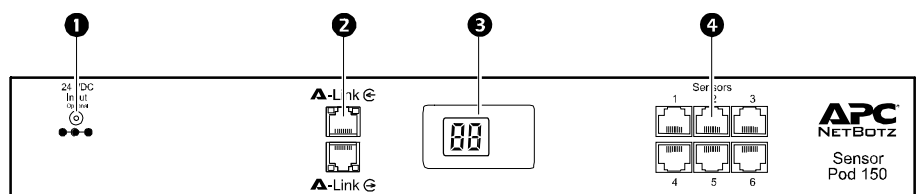

	Item	Description
❶	24 VDC Input	Provides supplemental power for high-current load configurations. Supplemental power is not required for most system configurations. See the installation instructions for your appliance to determine whether supplemental power is required.
❷	A-Link ports <ul style="list-style-type: none"> <li>• Top port <b>in</b></li> <li>• Bottom port <b>out</b></li> </ul>	Used for connecting the NetBotz 150 to a NetBotz Rack Monitor 200 (NBRK0200), NetBotz Rack Monitor 450 (NBRK0450), NetBotz Room Monitor 455 (NBWL0455), or NetBotz Rack Monitor 550 (NBRK0550). Standard CAT-5 cabling with straight-through wiring is required. Depending on the rack or room monitor to which the NetBotz 150 is connected, multiple devices may be cascaded along an A-Link bus.
❸	Identifier # LED display	<p>Displays a unique identifier number. The first time a Rack Sensor Pod 150 receives power, it obtains a unique Identifier #.</p> <p>When the NetBotz 150 is connected to a NetBotz Rack Monitor 450 (NBRK0450), NetBotz Room Monitor 455 (NBWL0455), or NetBotz Rack Monitor 550 (NBRK0550), the Identifier # LED will blink when an alert occurs for the NetBotz 150.</p> <p>During a firmware upgrade, the Identifier # LED displays <b>88</b>. (See “Upgrade the NetBotz 150” on page 7 for more information on firmware upgrades.)</p>
❹	Sensor ports	<p>Used for connecting APC sensors, third-party dry contact sensors, and standard third-party 0-5 V sensors. (See “Additional options” on page 2 for details on APC sensor options.)</p> <p>Third-party dry contact sensors require the NetBotz Dry Contact Cable (NBES0304). Standard third-party 0-5 V sensors require the NetBotz 0-5 V Sensor Cable (NBES0305).</p>

# Inventory

Inspect the contents of the package to ensure that the parts included match those shown below. Report missing or damaged contents to APC or your APC reseller. However, if damage was due to shipping, immediately report the damage to the shipping agent.



The shipping and packaging materials are recyclable. Please save them for later use or dispose of them appropriately.

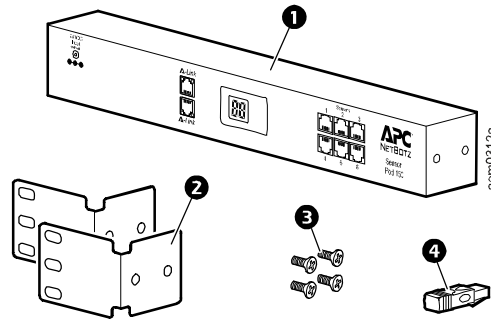

Item	Description
1	NetBotz Rack Sensor Pod 150
2	Brackets for a standard 19-in rack
3	8-32 x 1/4-in Phillips head screws
4	A-Link terminator
	Temperature/Humidity Sensor (AP9335TH)—not shown



# Install the NetBotz 150

Choose the option below that meets your needs. Then connect the NetBotz 150 to your appliance by following the instructions in the installation and quick configuration manual included with the appliance.



**Note:** Install the NetBotz 150 in an environment compatible with the environmental specifications on page 8.

**Note:** When you install the NetBotz 150 in the rack, do not create a hazardous condition due to uneven mechanical loading. For example, do not use the NetBotz 150 as a shelf.

## Toolless peg-mount installation



**Note:** The toolless peg-mount installation is only available with a NetShelter VX or SX rack.

In the left or right cable channel in the rear panel of the enclosure, install the NetBotz 150 in a set of mounting holes. Be sure to push down until it locks.

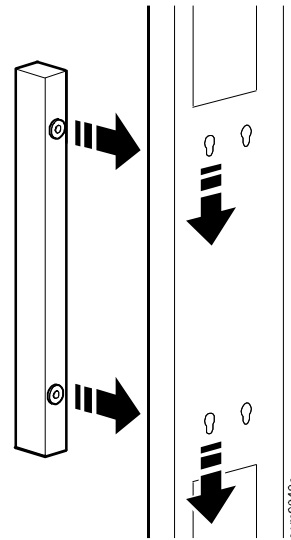

## Rack-mount installation

1. Choose a location for the NetBotz 150 in the front or rear of the rack. The NetBotz 150 occupies one U-space. A notched hole or a number on the vertical rail of the rack denotes the middle of a U-space.

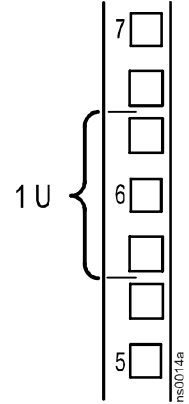

**Note:** To avoid equipment damage, use only the hardware provided when installing the brackets.

2. Install the brackets on each end of the NetBotz 150.

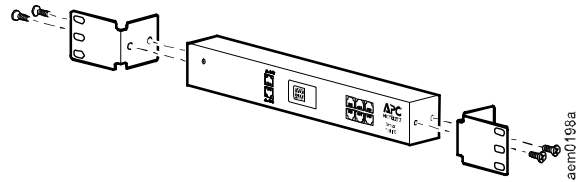

3. Secure the NetBotz 150 to the rack, using cage nuts and screws (provided with the rack).

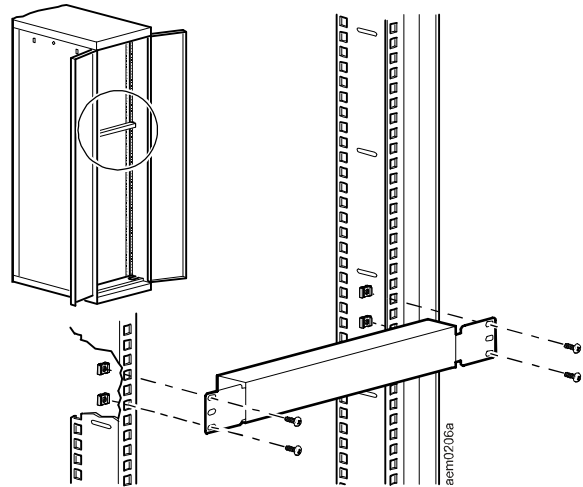

# Connect Sensors

Only connect sensors supported by the appliance to which the NetBotz 150 is connected. See the installation and quick configuration manual included with your appliance.



**Caution:** Only connect approved devices to ports on the NetBotz 150 as directed in this manual. Plugging in other devices may result in equipment damage.

Connect APC and third-party sensors to the six ports labeled **Sensors** on the NetBotz 150.

- Third-party dry contact sensors require the NetBotz Dry Contact Cable (NBES0304). To connect a sensor to the cable, follow the instructions provided with the sensor and the instructions provided with the cable.
- Standard third-party 0-5 V sensors require the NetBotz 0-5 V Sensor Cable (NBES0305). To connect a sensor to the cable, follow the instructions provided with the sensor and the instructions provided with the cable.
- If a sensor cable is not long enough, use an RJ-45 coupling (provided with some sensors) and standard CAT-5 cabling to extend the cable up to 15 m (50 ft) for a Temperature/Humidity Sensor (AP9335TH) or a Temperature Sensor (AP9335T) and up to 30.5 m (100 ft) for all other supported sensors.

## Configure and Monitor Sensors

Once your system is installed and receiving power, configure sensors and begin monitoring your system using the software interface for the appliance.



See your appliance installation and quick configuration manual for system installation details and for instructions on accessing the software interface of the appliance.

## Upgrade the NetBotz 150

Firmware upgrades for NetBotz 150s are included with firmware upgrades for NetBotz appliances. When you upgrade firmware for the appliance to which the NetBotz 150 is connected, the NetBotz 150 firmware will be updated automatically, if required.



**Note:** The NetBotz 150 Identifier # LED shows **88** during a firmware upgrade. During the upgrade, data from sensors connected to the NetBotz 150 will be invalid.

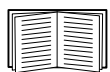

For more information on firmware upgrades, see your appliance user's guide. For details on how to access your appliance user's guide, see "Additional documentation" on page 1.

## Clean the NetBotz 150

To clean the device, gently wipe surfaces with a clean, dry cloth.

# Specifications

---

## Electrical

---

Input voltage, nominal	24 VDC; 50–175 mA
Maximum total current draw	175 mA

---

## Physical

---

Dimensions (H x W x D)	44.2 x 337.0 x 44.2 mm (1.74 x 13.25 x 1.74 in)
Shipping dimensions (H x W x D)	67 x 450 x 225 mm (2.6 x 17.8 x 8.9 in)
Weight	0.70 kg (1.50 lb)
Shipping weight	1.80 kg (4.00 lb)

---

## Environmental

---

Elevation (above MSL)	
Operating	0 to 3000 m (0 to 10,000 ft)
Storage	0 to 15 000 m (0 to 50,000 ft)
Temperature	
Operating	0 to 45°C (32 to 113°F)
Storage	–15 to 65°C (5 to 149°F)
Humidity	
Operating	0 to 95%, non-condensing
Storage	0 to 95%, non-condensing

---

## Compliance

---

Immunity/Emissions	CE, FCC Part 15 Class A, ICES-003 Class A, VCCI Class A, EN 55022 Class A, EN 55024, AS/NZS CISPR 22
--------------------	--

---

# Two-Year Factory Warranty

This warranty applies only to the products you purchase for your use in accordance with this manual.

## Terms of warranty

APC warrants its products to be free from defects in materials and workmanship for a period of two years from the date of purchase. APC will repair or replace defective products covered by this warranty. This warranty does not apply to equipment that has been damaged by accident, negligence or misapplication or has been altered or modified in any way. Repair or replacement of a defective product or part thereof does not extend the original warranty period. Any parts furnished under this warranty may be new or factory-remanufactured.

## Non-transferable warranty

This warranty extends only to the original purchaser who must have properly registered the product. The product may be registered at the APC Web site, [www.apc.com](http://www.apc.com).

## Exclusions

APC shall not be liable under the warranty if its testing and examination disclose that the alleged defect in the product does not exist or was caused by end user's or any third person's misuse, negligence, improper installation or testing. Further, APC shall not be liable under the warranty for unauthorized attempts to repair or modify wrong or inadequate electrical voltage or connection, inappropriate on-site operation conditions, corrosive atmosphere, repair, installation, exposure to the elements, Acts of God, fire, theft, or installation contrary to APC recommendations or specifications or in any event if the APC serial number has been altered, defaced, or removed, or any other cause beyond the range of the intended use.

**THERE ARE NO WARRANTIES, EXPRESS OR IMPLIED, BY OPERATION OF LAW OR OTHERWISE, OF PRODUCTS SOLD, SERVICED OR FURNISHED UNDER THIS AGREEMENT OR IN CONNECTION HEREWITH. APC DISCLAIMS ALL IMPLIED WARRANTIES OF MERCHANTABILITY, SATISFACTION AND FITNESS FOR A PARTICULAR PURPOSE. APC EXPRESS WARRANTIES WILL NOT BE ENLARGED, DIMINISHED, OR AFFECTED BY AND NO OBLIGATION OR LIABILITY WILL ARISE OUT OF, APC RENDERING OF TECHNICAL OR OTHER ADVICE OR SERVICE IN CONNECTION WITH THE PRODUCTS. THE FOREGOING WARRANTIES AND REMEDIES ARE EXCLUSIVE AND IN LIEU OF ALL OTHER WARRANTIES AND REMEDIES. THE WARRANTIES SET FORTH ABOVE CONSTITUTE APC'S SOLE LIABILITY AND PURCHASER'S EXCLUSIVE REMEDY FOR ANY BREACH OF SUCH WARRANTIES. APC WARRANTIES EXTEND ONLY TO PURCHASER AND ARE NOT EXTENDED TO ANY THIRD PARTIES.**

**IN NO EVENT SHALL APC, ITS OFFICERS, DIRECTORS, AFFILIATES OR EMPLOYEES BE LIABLE FOR ANY FORM OF INDIRECT, SPECIAL, CONSEQUENTIAL OR PUNITIVE DAMAGES, ARISING OUT OF THE USE, SERVICE OR INSTALLATION, OF THE PRODUCTS, WHETHER SUCH DAMAGES ARISE IN CONTRACT OR TORT, IRRESPECTIVE OF FAULT, NEGLIGENCE OR STRICT LIABILITY OR WHETHER APC HAS BEEN ADVISED IN ADVANCE OF THE POSSIBILITY OF SUCH DAMAGES. SPECIFICALLY, APC IS NOT LIABLE FOR ANY COSTS, SUCH AS LOST PROFITS OR REVENUE, LOSS OF EQUIPMENT, LOSS OF USE OF EQUIPMENT, LOSS OF SOFTWARE, LOSS OF DATA, COSTS OF SUBSTITUENTS, CLAIMS BY THIRD PARTIES, OR OTHERWISE.**

**NO SALESMAN, EMPLOYEE OR AGENT OF APC IS AUTHORIZED TO ADD TO OR VARY THE TERMS OF THIS WARRANTY. WARRANTY TERMS MAY BE MODIFIED, IF AT ALL, ONLY IN WRITING SIGNED BY AN APC OFFICER AND LEGAL DEPARTMENT.**

### **Warranty claims**

Customers with warranty claims issues may access the APC customer support network through the Support page of the APC Web site, [www.apc.com/support](http://www.apc.com/support). Select your country from the country selection pull-down menu at the top of the Web page. Select the Support tab to obtain contact information for customer support in your region.

### **Obtaining service**

To obtain support for problems with your NetBotz Rack Sensor Pod 150:

1. Note the serial number. The serial number is printed on a label located on the bottom of the unit.
2. Contact Customer Support using the information on the back cover of this manual. A technician will try to help you solve the problem by phone.
3. If you must return the product, the technician will give you a return material authorization (RMA) number. If the warranty expired, you will be charged for repair or replacement.
4. Pack the unit carefully. The warranty does not cover damage sustained in transit. Enclose a letter with your name, address, RMA number and daytime phone number; a copy of the sales receipt; and a check as payment, if applicable.
5. Mark the RMA number clearly on the outside of the shipping carton.
6. Ship by insured, prepaid carrier to the address provided by the Customer Support technician.

# Radio Frequency Interference



Changes or modifications to this unit not expressly approved by the party responsible for compliance could void the user's authority to operate this equipment.

## USA—FCC

This equipment has been tested and found to comply with the limits for a Class A digital device, pursuant to part 15 of the FCC Rules. These limits are designed to provide reasonable protection against harmful interference when the equipment is operated in a commercial environment. This equipment generates, uses, and can radiate radio frequency energy and, if not installed and used in accordance with this user manual, may cause harmful interference to radio communications. Operation of this equipment in a residential area is likely to cause harmful interference. The user will bear sole responsibility for correcting such interference.

## Canada—ICES

This Class A digital apparatus complies with Canadian ICES-003.

*Cet appareil numérique de la classe A est conforme à la norme NMB-003 du Canada.*

## Japan—VCCI

This is a Class A product based on the standard of the Voluntary Control Council for Interference by Information Technology Equipment (VCCI). If this equipment is used in a domestic environment, radio disturbance may occur, in which case, the user may be required to take corrective actions.

この装置は、情報処理装置等電波障害自主規制協議会（VCCI）の基準に基づくクラス A 情報技術装置です。この装置を家庭環境で使用すると、電波妨害を引き起こすことがあります。この場合には、使用者が適切な対策を講ずるよう要求されることがあります。

## Taiwan—BSMI

警告使用者：  
這是甲類的資訊產品，在居住的環境中使用時，可能會造成射頻干擾，在這種情況下，使用者會被要求採取某些適當的對策。

## Australia and New Zealand

**Attention:** This is a Class A product. In a domestic environment this product may cause radio interference in which case the user may be required to take adequate measures.

## European Union

This product is in conformity with the protection requirements of EU Council Directive 2004/108/EC on the approximation of the laws of the Member States relating to electromagnetic compatibility. APC cannot accept responsibility for any failure to satisfy the protection requirements resulting from an unapproved modification of the product.

This product has been tested and found to comply with the limits for Class A Information Technology Equipment according to CISPR 22/European Standard EN 55022. The limits for Class A equipment were derived for commercial and industrial environments to provide a reasonable protection against interference with licensed communication equipment.

**Attention:** This is a Class A product. In a domestic environment this product may cause radio interference in which case the user may be required to take adequate measures.

# APC Worldwide Customer Support

Customer support for this or any other APC product is available at no charge in any of the following ways:

- Visit the APC Web site to access documents in the APC Knowledge Base and to submit customer support requests.
  - **www.apc.com** (Corporate Headquarters)  
Connect to localized APC Web sites for specific countries, each of which provides customer support information.
  - **www.apc.com/support/**  
Global support searching APC Knowledge Base and using e-support.
- Contact the APC Customer Support Center by telephone or e-mail.
  - Local, country-specific centers: go to **www.apc.com/support/contact** for contact information.

For information on how to obtain local customer support, contact the APC representative or other distributors from whom you purchased your APC product.

Entire contents copyright 2008 American Power Conversion Corporation. All rights reserved. Reproduction in whole or in part without permission is prohibited. APC, the APC logo, InfraStruXure, NetBotz, and NetShelter are trademarks of American Power Conversion Corporation. All other trademarks, product names, and corporate names are the property of their respective owners and are used for informational purposes only.



990-3285A-001



8/2008