

Eaton® Enclosure Power Distribution Unit (ePDU®) G3

Operations Manual



Powering Business Worldwide

Eaton and ePDU are registered trademarks of Eaton or its subsidiaries and affiliates. Google Chrome is a trademark of Google, Inc. HyperTerminal is a registered trademark of Hilgraeve. Linux is a registered trademark of Linus Torvalds in the United States, other countries, or both. Microsoft, Internet Explorer, Vista, and Windows are registered trademarks of Microsoft Corporation in the United States and other countries. Mozilla and Firefox are registered trademarks of the Mozilla Foundation. National Electrical Code and NEC are registered trademarks of National Fire Protection Association, Inc. Phillips is a registered trademark of Phillips Screw Company. Rittal is a registered trademark of Rittal GmbH & Co. KG. All other trademarks are property of their respective companies.

©Copyright 2015–2016 Eaton, Raleigh NC, USA. All rights reserved. No part of this document may be reproduced in any way without the express written approval of Eaton.

Class A EMC Statements

FCC Information

This equipment has been tested and found to comply with the limits for a Class A digital device, pursuant to part 15 of the FCC Rules. These limits are designed to provide reasonable protection against harmful interference when the equipment is operated in a commercial environment. This equipment generates, uses and can radiate radio frequency energy and, if not installed and used in accordance with the instruction manual, may cause harmful interference to radio communications. Operation of this equipment in a residential area is likely to cause harmful interference in which case the user will be required to correct the interference at his own expense.

ICES-003

This Class A Interference Causing Equipment meets all requirements of the Canadian Interference Causing Equipment Regulations ICES-003.

Cet appareil numérique de la classe A respecte toutes les exigences du Règlement sur le matériel brouilleur du Canada.

Eaton is not responsible for damage to this product resulting from accident, disaster, misuse, abuse, non-Eaton modification of the product, or other events outside the reasonable control of Eaton or not arising under normal operating conditions.



Special Symbols

The following are examples of symbols used on the ePDU or accessories to alert you to important information:



RISK OF ELECTRIC SHOCK - Observe the warning associated with the risk of electric shock symbol.



CAUTION: REFER TO OPERATOR'S MANUAL - Refer to your operator's manual for additional information, such as important operating and maintenance instructions.



This symbol indicates that you should not discard waste electrical or electronic equipment (WEEE) in the trash. For proper disposal, contact your local recycling/reuse or hazardous waste center.

Table of Contents

1	INTRODUCTION	10
	Description	10
	Product Specifications	12
	Eaton ePDU Models	12
	LCD Interface	14
	Circuit Breakers	15
	Power Outlets	16
	Input Power Cord	16
	Accessories	16
	Environmental Monitoring Probe	16
	Features	17
	Ease of Use	17
	Communication	17
	Power Control Management	17
	Monitoring	17
	Configurability and Security	17
	Acknowledgements	18
2	SAFETY WARNINGS	19
3	INSTALLATION	21
	Installation Precautions	21
	Inspecting the Equipment	22
	Package Contents	23
	Optional Environmental Monitoring Probe	24
	Brackets for Cisco Racks (US only)	24
	Installation Overview	26
	Tools	26
	Configurations	27
	Power Feed Labels	28
	Chassis Hole Pattern (EMEA models only)	29
	Mounting Buttons	30
	IEC Outlet Grip Plug Retention Mechanism	31
	Installing Vertical ePDUs in a Rack Cabinet	31
	Using Factory-installed Mounting Buttons	32
	Using Mounting Buttons Installed on Clip Feet (52 mm Wide Vertical Models Only)	33
	Using Clip Feet and Cage Nuts on a Square-hole Rack	34
	Using Mounting Brackets for Cisco Racks (US only, 52 mm Wide Vertical Models Only)	35
	Installing the Horizontal Models in a Rack Cabinet	39
	Grounding the ePDU	40
	Network and Environmental Ports	42
	Connecting to a Computer Serial Port	42
	Connecting to a LAN Ethernet Port	43
	Connecting Multiple ePDUs in a Daisy Chain	43
	Connecting Optional Environmental Monitoring Probe Equipment	45
	Connecting the Output Devices	46
	Operating the ePDU	47

- 4 OPERATION OVERVIEW 48**
 - Operation Interfaces 48
 - Local Operation Interface 48
 - Remote Operation Interfaces 50
 - Outlets and Circuit Breakers 50
 - Ports, Operation Buttons, and LED Status Indicators 51
 - Operation Concepts 52
 - User Login and Access Policy 52
 - Common Operations 53
 - Starting the ePDU 53
 - Shutting Down the ePDU 53
 - Restarting the ePDU Network Management and Control (eNMC) module 53

- 5 NETWORK COMMUNICATION CONFIGURATION 56**
 - LCD — DHCP 56
 - LCD— Static IP address 57
 - Serial connection — Static IP address 58
 - Verify Web Operation After Configuration 59

- 6 LCD INTERFACE OPERATION 60**
 - LCD Display and Control Buttons 60
 - Operation Mode 62
 - Screensaver Cycling Sequence 62
 - Startup Screen 62
 - Password Protected Menus 63
 - Main Menu Selections 63
 - Active Alarms Menu 65
 - Alarms History Menu 66
 - Meter Menu 66
 - ePDU Submenu 67
 - Sections Submenu 68
 - Outlets Submenu 69
 - Environment Submenu 69
 - Control Menu 70
 - Settings Menu 70
 - USB Flash Mode Submenu 71
 - Display Submenu 76
 - Daisy Chain Submenu 77
 - IPv4 Submenu 80
 - Language Submenu 80
 - Factory Submenu 81
 - ePDU Info Menu 81

- 7 SERIAL INTERFACE OPERATION 82**
 - Supported Commands 82
 - ? command 83
 - info command 84
 - quit command 86
 - get command 86

set command	88
pdu command	91
Error Messages	91
XML Object Tables	91
8 WEB INTERFACE OPERATION	92
Navigating the Web Interface	92
Languages	94
Accessing the Web Interface	95
Menu Selections	96
Power Management	97
Logs & Notifications	97
Settings	97
Network	98
Access Privileges	98
Administrator	98
Local or Remote Administrator	99
ePDU-User	100
Outlet-User	101
Session Management	102
Overview	102
Review/Modify ePDU Data	102
Branch Circuits	104
Review Branch Circuits	104
Change Groups Measurements Settings	104
Turn Sections On or Off	105
Change Individual Section Settings	105
Devices	106
Review Devices	106
Add Devices	107
Delete Devices	108
Turn Devices On or Off	108
Change Device Settings	108
Outlets	110
Review/Modify ePDU Outlets	110
Environment	111
Configure Environment Sensor Settings	111
Power Schedule	112
Define a Power Schedule	112
Active Alarms	114
Review Active Alarms	114
Logs	114
Clear the Event Log	114
Download the Event Log as a Comma Separated Value File	114
Trap Notification	115
Define the Trap Receivers	115
Syslog	116
Retrieve or Modify Syslog Data	116

Access Accounts	117
Configure the SuperUser	117
Configure the E-mail Notification Settings	117
Configure the LCD Password	117
Configure Local User Access	118
Configure Remote Group Access	119
System	119
Set General System Settings	120
Enable/Disable Firmware Upgrade	120
Configure ePDU Network Management and Control Module	121
Perform Firmware Upgrade	121
ePDU Configuration	122
Date & Time	122
Manually Configure the Date and Time	122
Automatically Configure the Date and Time	123
TCP/IP	123
Configure the Ethernet Link Speed and Duplex Mode	123
Configure the IPv4 Settings	124
Configure the IPv6 Settings	124
Configure the DNS	125
Configure the SMTP	125
SNMP	126
Enable/Disable the SNMP Agent	126
Define SNMPv1 Users	126
Define SNMPv3 User-based Security Model Users	126
Access Eaton ePDU MIB Objects (Privileged Access Only)	127
Energy Wise	127
Enable Energy Wise	127
Disable Energy Wise	127
Start/Stop Energy Wise Commands	128
Security	128
Enable/Disable SSL Encryption	128
Enable/Disable the Telnet Interface	129
Enable/Disable the SSH Interface	129
Enable/Disable FTP	130
Set Authentication Mode	130
Set LDAP Search Configuration	130
Authenticate LDAP Remote User	131
Set LDAP Server Global Parameters	133
Modify LDAP Server Settings	133
Add RADIUS Server	134
Edit Parameters for a RADIUS Server	134
9 MAINTENANCE AND ALARMS	135
Preventive Maintenance	135
Equipment Disposal	135
Replacing the ePDU Network Management and Control Module	135
Restarting the eNMC Module and Resetting the ePDU	139

Firmware Upgrade	139
Upgrading Firmware with Hypertext Transfer Protocol	140
Upgrading the Firmware with FTP Protocol	142
Upgrading the Firmware with the USB Port	144
Active Alarms	144
Defining the Alarm or Event Condition	145
Type Code 0 or 1 (OS or System)	145
Type Code 2 or 3 (ePDU or User)	147
10 SERVICE AND SUPPORT	152
11 WARRANTY	153

Chapter 1 Introduction

Description

The Eaton® Enclosure Power Distribution Unit (ePDU®) G3 is an intelligent ePDU that is designed to distribute power within a standard 19-inch rack. A wide range of models let you connect and manage a variety of outlets from a single power connection. Most models have monitoring or switching capabilities, or both.

Figure 1 and Figure 2 show examples of installed G3 Eaton ePDUs.

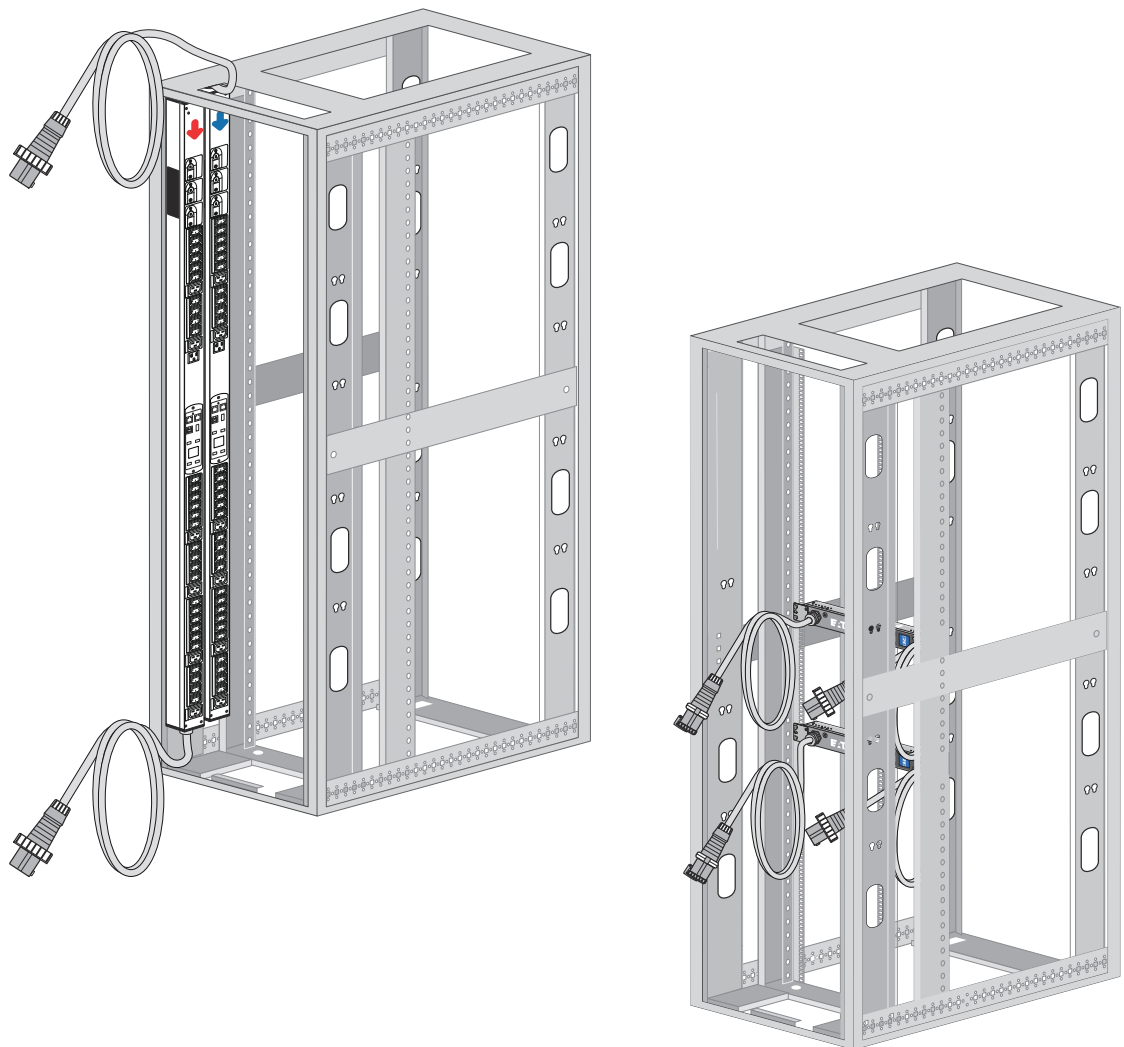

Figure 1. Example ePDU G3 Installations

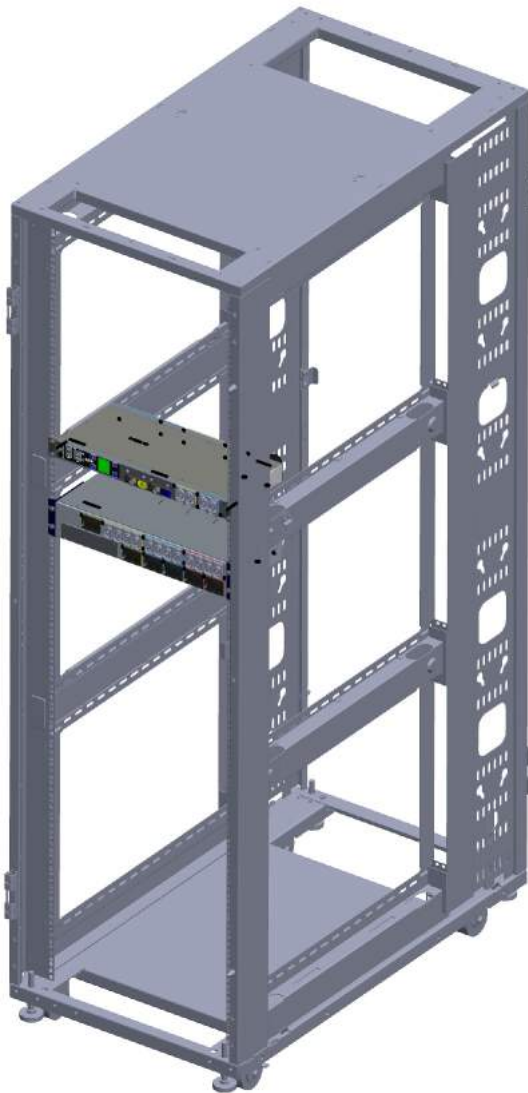

Figure 2. Example ePDU G3 Installations (1U and 2U Models)

The ePDU G3 family provides six different ePDU topologies. The monitoring or switching capabilities are characterized as follows:

- Basic (BA) with no monitoring or intelligent controls
- In-Line Metered (IL) with monitoring at the input
- Metered Input (MI) with monitoring at the input and branch
- Metered Outlet (MO) with monitoring at the input, branch, and individual outlet monitoring, but no outlet control
- Switched (SW) with control of outlets but no individual outlet monitoring
- Managed (MA) with monitoring at the input, branch, and individual outlet control and monitoring



NOTE

These capabilities are expressed in the model numbers of the ePDUs.

Table 1 shows which main features are implemented or not implemented, depending on the topology:

Table 1. Monitoring and Management Features Available for ePDU Topologies

Models	Input Metering	Branch Metering	Outlet Metering	Outlet Switching	Environmental Sensor Monitoring
Basic (BA)	—	—	—	—	—
In-Line Metered (IL)	•	—	—	—	•
Metered Input (MI)	•	•	—	—	•
Metered Outlet (MO)	•	•	•	—	•
Switched (SW)	•	•	—	•	•
Managed (MA)	•	•	•	•	•

NOTE Environmental sensor monitoring is only available if an Environmental Monitoring Probe (EMP) is attached.

Product Specifications

Find product specifications, diagrams, part number and ordering matrix documents, and marketing collateral at www.eaton.com/ePDU.

Eaton ePDU Models

The Eaton ePDU models support world-wide markets. These model types are defined primarily by the system management and monitoring capabilities, but the capabilities are also defined by the hardware configurations.

The ePDU models support single-phase applications (or three-phase for Americas models) and can manage 6 to 42 outlets. Network-connected models feature an LCD display and LEDs to indicate status on communication connectors. Managed models contain LEDs to indicate outlet status. Most ePDUs have attached power cords and circuit breakers (see Figure 3).



NOTE Select models have detachable input power cords.

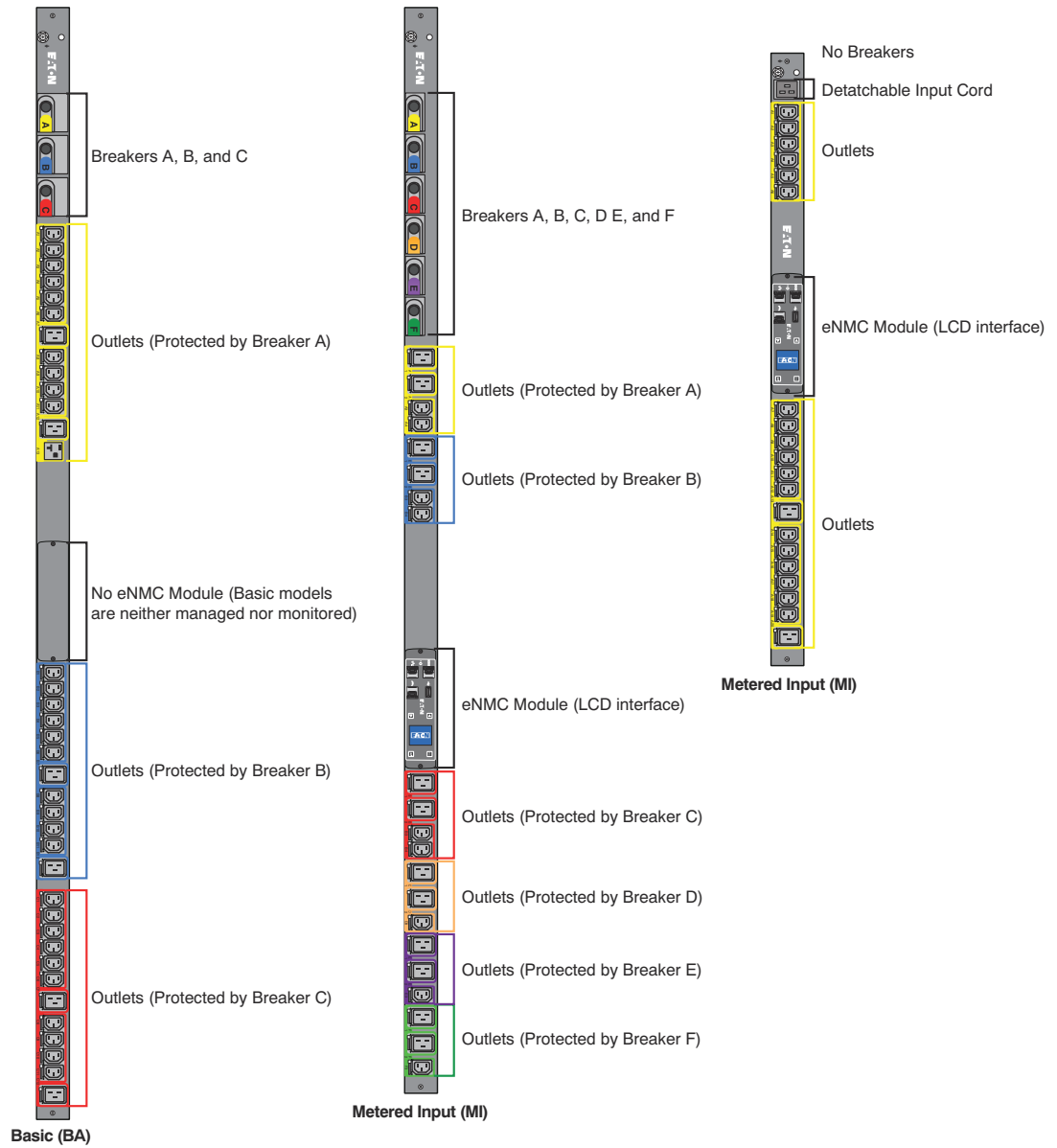

Figure 3. Example ePDU G3 Products

LCD Interface

The LCD interface is operated using the LCD display, buttons, and ports of the embedded communications module (ePDU Network Management and Control (eNMC) module). See Figure 4.

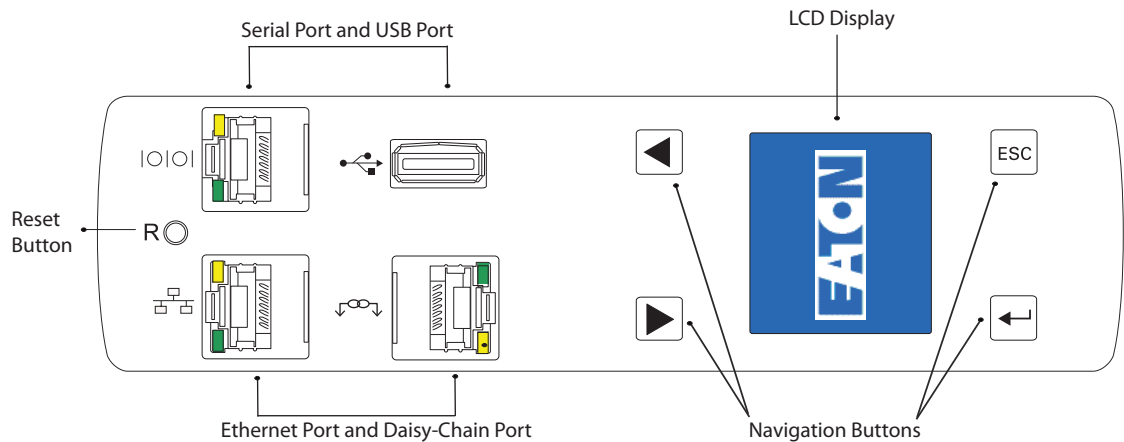

Figure 4. LCD Interface Front Panel (0U Models)

LCD Display

The LCD display provides information about load status, events, measurements, identification, and settings. The LCD interface also provides some basic configuration. For more information, see “Operation Interfaces” on page 48.

Navigation Buttons

Navigate through the display with buttons. For more information, see “Ports, Operation Buttons, and LED Status Indicators” on page 51.

Reset Button

Restart (reset) the ePDU Network Management and Control (eNMC) module through this button. Insert and retract a probe in the reset button opening to perform a communications module restart.



NOTE Resetting the ePDU does not affect the power to the outlets.

Connectivity and Serial Ports

- ▮ **Serial or Environmental Monitoring Probe (EMP) Port.** Connects to the serial (COM) RS-232 connector on a computer with a DB9-to-RJ-45 cable, allowing the computer to act as a configuration console. As an alternative, the connection can be used to connect an optional EMP in order to collect temperature and humidity data.
- ▮ **Ethernet Port Connector.** Connects to a LAN, allowing configuration through a 10/100 autosensing network connection.
- ▮ **Daisy-Chain Port Connector.** Used to daisy-chain up to eight ePDUs together to use a single Ethernet connection.
- ▮ **USB Port.** Used for firmware upgrade.

Circuit Breakers

Circuit breakers activate if the load current rating of an outlet section exceeds 16A (Europe) / 20A (US). Power to the outlet turns off automatically. To reset the circuit breaker, turn the breaker from Off to On.

NOTE 1 The On/Off positions are indicated on the circuit breakers.



NOTE 2 To manually disconnect power to a device that is connected to the ePDU, disconnect the device power cord from the ePDU outlet.

NOTE 3 To disconnect power on models without a circuit breaker, disconnect the ePDU input power cord.

Figure 5 shows circuit breaker examples.

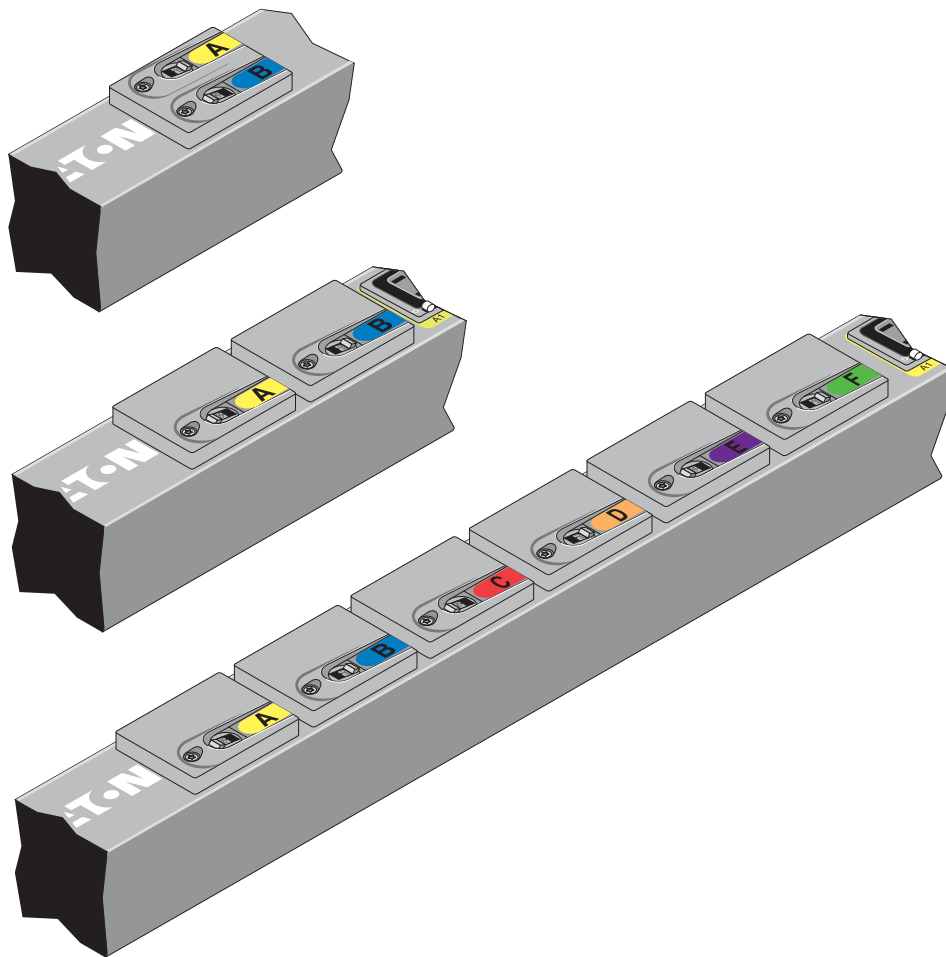

Figure 5. Circuit Breakers

Power Outlets

Each model has a specific configuration of standard NEMA outlets, IEC 60320 and IEC 60309 outlets, EMEA national types (French, Schuko, and UK), or other outlet types (for example, RF-203P-HP 277 VAC). Many configurations are available or the configurations can be customized to match your needs.

The outlets are grouped in sets called sections. Outlet sections are preset groups of individual outlets that you can identify and monitor through the different interfaces that are available with the ePDU.

The outlets are color-coded and labeled. If the model has circuit breakers, the circuit breakers that are associated with the outlets have corresponding labels (see Figure 6).

You can connect one device to each outlet. For more information, see “Outlets and Circuit Breakers” on page 50.

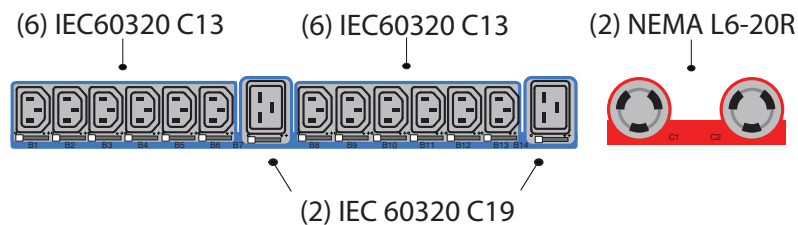

Figure 6. Example Outlet Types

Input Power Cord

Use the input power cords to connect to the power source. Input power cords are permanent for most models. Select models have detachable input power cords.

Accessories

Environmental Monitoring Probe

The Environmental Monitoring Probe (EMP) accessory is optional and must be purchased separately. The optional EMP provides monitoring of external temperature, humidity, and the status of two contact devices, providing greater power management control and flexible monitoring. The EMP has the following features:

- Simplified installation lets you install the EMP safely without turning off power to the ePDU or to the devices that are connected to it.
- The EMP monitors temperature and humidity information of any environment, protecting your critical equipment. The EMP measures temperatures between 0°C and 80°C (32°F and 176°F) with an accuracy of $\pm 1^\circ\text{C}$. The EMP measures relative humidity between 10% and 90% with an accuracy of $\pm 5\%$.
- The EMP can be located away from the ePDU with a Category 5 network cable up to 20m (65.6 ft) long.
- The EMP monitors the status of two user-supplied contact devices.
- Temperature, humidity, and contact closure status can be displayed through a variety of interfaces.
- User-selectable alarm thresholds let you define acceptable temperature or humidity limits.
- You can use e-mail client software to set up e-mail notification through Simple Network Management Protocol (SNMP) when acceptable alarm limits are exceeded or contact status changes.
- Changes in external contact status are logged in the ePDU event history log.
- When temperature and humidity values exceed user-selectable limits, the event is logged in the ePDU event history log.



NOTE

For information updates, refer to the Eaton ePDU catalog or go to www.eaton.com/ePDU.

Features

The Eaton ePDUs provide outstanding performance and reliability, including some or all of these benefits (varies by model):

Ease of Use

- † Easy and flexible rack installation
- † Easy-to-use interface to display input and output status
- † Color-coded outlets and circuit breakers for easy correlation
- † A visual alarm (blinking LED) to indicate outlet current overload
- † User-friendly firmware updates

Communication

- † Comprehensive power management and flexible configuration through a Web browser or a serial connection, a Telnet connection, SNMP, or a console emulator such as HyperTerminal®.
- † Compatibility with Eaton and third party network management software is facilitated by SNMP protocol or CLI scripts. Eaton Intelligent Power Manager (IPM) uses XML to communicate to the ePDU.

Power Control Management

- † Control of outlets for Switched or Managed ePDUs, both collectively and individually
- † The ability to power on, power off, and reboot the devices connected to each outlet
- † Fully shrouded local branch circuit breakers on products rated over 16A (Europe) / 20A (US) to protect connected equipment against overload and short circuits
- † Configuring and monitoring the power schedule of outlets

Monitoring

- † Monitoring of the following:
 - Root Square Mean (RMS) current
 - Crest factor
 - Power factor
 - Maximum and minimum thresholds for current or voltage
 - RMS voltage
 - Active power
 - Apparent power
 - Energy
- † Monitoring of the ePDU locally or remotely through a console or network
- † Remote monitoring of connected devices and sensors
- † Daily history report through e-mail
- † Dual color LCD for higher visibility on local alarms

Configurability and Security

- † Configurable alarm thresholds
- † Enterprise security using LDAP or RADIUS

Acknowledgements

The Eaton software development team is grateful to the following projects:

- OpenLDAP (<http://www.openldap.org/>)
- Cyrus SASL developed by Computing Services at Carnegie Mellon University (<http://www.cmu.edu/computing/>)
- uthash hash table (<http://uthash.sourceforge.net>)
- Expat XML Parser
- Symmetric Cipher Algorithm (Pukall Cipher 1) by Alexander PUKALL
- STM32F2xx standard peripherals library STSW-STM32062 by STMicroelectronics
- Radius library (<http://freeradius.org>)

The full license version for each of these projects is available in the web interface main page from the ePDU information panel by clicking the link next to the “Licenses” label.

Chapter 2 Safety Warnings

IMPORTANT SAFETY INSTRUCTIONS — SAVE THESE INSTRUCTIONS

This manual contains important instructions that you should follow during installation and operation of the Eaton Enclosure Power Distribution Unit (ePDU) G3. Please read all instructions before operating the equipment and save this manual for future reference.

DANGER

This ePDU contains **HAZARDOUS VOLTAGES**. All repairs and service should be performed by **AUTHORIZED SERVICE PERSONNEL ONLY**. There are **NO USER SERVICEABLE PARTS** inside the ePDU. **SYSTEMS SHOULD ONLY BE INSTALLED, TESTED, AND CONFIGURED BY A COMPETENT PERSON. IT IS ESSENTIAL THAT THIS EQUIPMENT IS CONNECTED TO AN ELECTRICAL SUPPLY THAT HAS PROTECTIVE GROUND CONDUCTOR.**

CAUTION

- To reduce the risk of fire or electric shock, install this ePDU in a temperature and humidity controlled, indoor environment, free of conductive contaminants. Do not operate near water or excessive humidity (95% maximum).
 - Both the room and rack air temperature must be within the operating range of the selected model.
 - Do not use a two-wire power cord in any product configuration.
 - Test AC outlets at your computer and monitor for proper polarity and grounding. Use only with grounded outlets at both the computer and monitor.
 - The installation power outlet used for the power supply to this equipment must be installed near the equipment and must be easily accessible.
 - When installing this product, it is essential that the distribution circuit supplying the product is protected by a branch circuit protection device with a maximum rating to suit the product maximum rating.
 - TO ISOLATE THIS EQUIPMENT, DISCONNECT ALL OF THE POWER SUPPLY PLUGS.
 - This product has been designed to conform to the latest safety requirements. In addition to compliance with standards for general use, it has been factory configured for use in rack mounting environments, aiding the installer in providing systems compliant with relevant standards.
 - Only use supplied ePDU mounting hardware and accessories. If necessary, contact your customer service representative for replacement parts.
 - This equipment is intended for installation in Restricted Access Locations such as computer rooms, network closets, and equipment racks.
-

 **CAUTION**

This product contains a lithium battery on the internal ePDU Network Management and Control (eNMC) module:

- The battery is not user-replaceable. There is risk of explosion if battery is replaced by an incorrect type.
 - Ensure that used batteries are disposed of according to the instructions. For more information, contact your local recycling/reuse or hazardous waste center for proper disposal information.
-

Chapter 3 Installation

All 0U Eaton Enclosure Power Distribution Unit (ePDU) G3 models are mounted vertically inside rack structures. The In-line Metered (IL) models are mounted horizontally or vertically. The 1U and 2U models are mounted horizontally. Use the information in this chapter to prepare, install, and connect the ePDU and optional accessories.

Installation Precautions

Before you install or connect the ePDU in a rack cabinet, observe the following precautions:

- Only a competent service person should install, test, or configure the ePDU and its optional accessories. It is the installer's responsibility to ensure that the selected product is installed to meet national and local safety regulations.
- Read and understand all warnings and cautions listed in "Safety Warnings" on page 19.
- Review the documentation that comes with your rack cabinet for safety and cabling information. Follow all installation and operation safety information provided.



NOTE

Removing the rack cabinet doors and side panels might make installation easier. See the rack cabinet documentation for more information.

-
- Verify that the room and rack air temperature is within the operating range of the selected model.
 - Take all necessary precautions to handle the weight of the devices.
 - Connect all power cords to properly wired and grounded electrical outlets.



CAUTION

The installation power outlet used for the power supply to this equipment must be installed near the equipment and must be easily accessible.

-
- Do not overload the power outlet when you install multiple devices in the rack cabinet.
 - To reduce the risk of fire, connect only to a circuit provided with branch circuit overcurrent protection with an A (ampere) rating in accordance with the NEC (National Electrical Code), ANSI/NFPA 70 or your local electrical code.
 - Verify that all equipment is unplugged from ePDU outlets before performing any testing.
 - For units without circuit breakers, the ePDU output power cannot be turned on and off with a button or switch. These ePDUs are always on when they are plugged in. These ePDUs are always off when they are unplugged.
 - For units with circuit breakers, the circuit breaker controls whether there is output power:
 - If the circuit breakers are on, there is output power, the LCD display is on, and the network communications module is operational.
 - If the circuit breakers are off, there is no output power, but the LCD display is on, and the network communications module is operational.
 - To turn off the ePDU, unplug it.

Inspecting the Equipment

If any equipment has been damaged during shipment, keep the shipping cartons and packing materials for the carrier or place of purchase, and file a claim for shipping damage. If you discover damage after acceptance, file a claim for concealed damage.

To file a claim for shipping damage or concealed damage: 1) File with the carrier within 15 days of receipt of the equipment; 2) Send a copy of the damage claim within 15 days to your service representative.

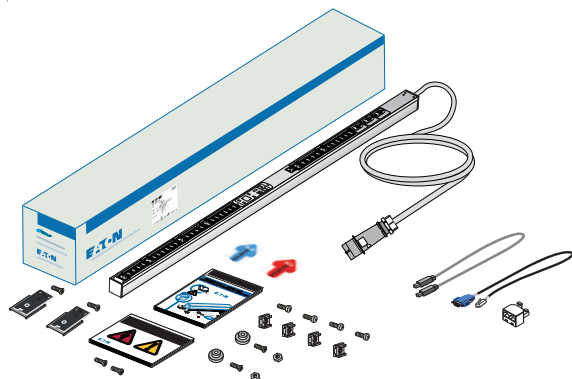

Figure 7. Example Shipping Carton and Contents (0U Model, Americas)



Figure 8. Example Shipping Carton and Contents (0U Model, EMEA)

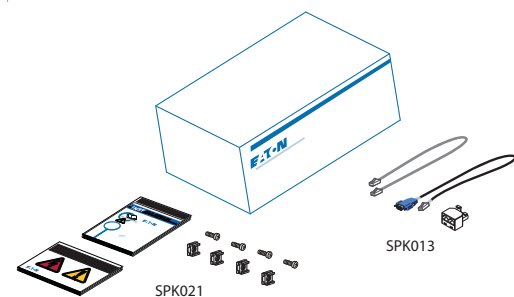

Figure 9. Example Shipping Carton and Contents (1U Model)

Package Contents

Table 2 lists the accessory parts that are included in the shipping carton with the ePDUs.

Table 2. Shipped with the ePDU in the Shipping Carton



Quantity	Description	
1 per language (varies by region)	<p><i>Eaton ePDU G3 Installation and Connectivity Quick Start (English)</i></p> <p>NOTE Supplied in the shipping carton and also available in several languages at www.eaton.com/ePDU.</p>	
1 per language (varies by region)	<p><i>Eaton ePDU G3 Safety Warnings and Service Reference Manual (English)</i></p> <p>NOTE Supplied in the shipping carton and also available in several languages at www.eaton.com/ePDU.</p>	
1	<p>Installation Pack for all 0U models:</p> <p>(1) Blue and (1) Red Arrow to indicate power source flow</p> <p>(2) Spare black plastic key hole buttons, (2) M4 screws (thread-forming) <small>SEE NOTE 2</small>, and (2) M4 nuts <small>SEE NOTE 3</small></p> <p>(4) M6 Cage nuts, (4) M6 dome screws, and (2) M6 Flat head screws</p> <p>(2) Clip feet</p> <p>NOTE 1 You may also have (2) M3 or M4 spare screws.</p> <p>NOTE 2 For EMEA models, M3-sized screws are provided.</p> <p>NOTE 3 For EMEA models, the M3 nuts are factory-installed in the clip feet.</p>	
1	<p>Installation Pack for all 1U/2U models:</p> <p>(4) M6 Cage nuts and (4) M6 dome screws</p>	

Table 2. Shipped with the ePDU in the Shipping Carton (Continued)

Quantity	Description
1	Network Pack for Network-connected models only: <ul style="list-style-type: none"> ▫ (1) Serial cable used for RS-232 connection between the ePDU and a PC ▫ (1) RJ-45 Cable (60cm - shielded) used for Ethernet or daisy-chain connection between the ePDU and a PC <small>SEE NOTE</small> (Americas models only) ▫ (1) Y Splitter installed in the Daisy-Chain port and used for daisy-chaining up to eight ePDUs together,

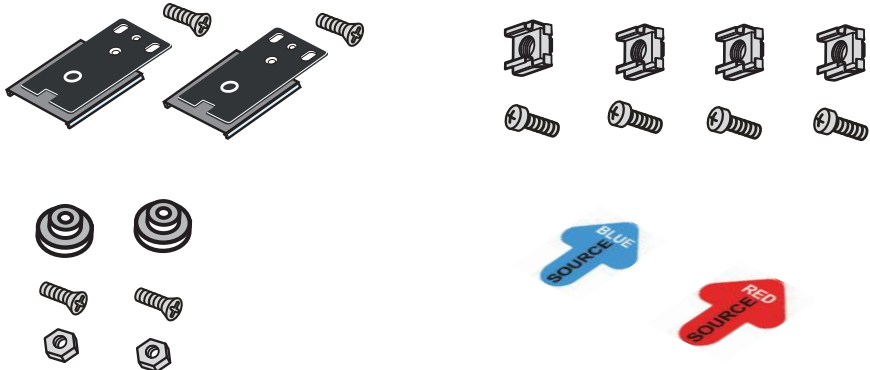
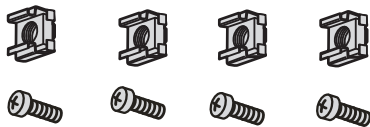
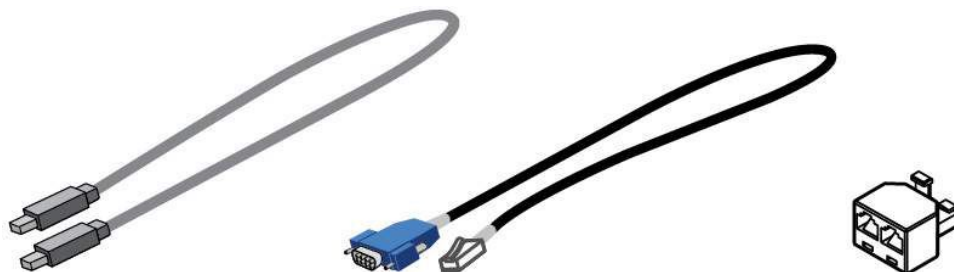

NOTE The short Ethernet cable is intended for setup or daisy chain. Longer standard network cables can be made or purchased separately.

NOTE Some ePDUs have detachable power cords which may or may not be included. Check specifications prior to ordering.

Optional Environmental Monitoring Probe

Optional Environmental Monitoring Probe (EMP) equipment with sensors can be connected to the ePDU as an accessory. The equipment is customer-supplied and should be installed using the manufacturer's instruction manual.



IMPORTANT

Follow all installation and operation safety information provided in the manufacturer's instruction manual for the EMP equipment. Use only supplied accessories.

Brackets for Cisco Racks (US only)

Brackets are available for installing ePDUs in Cisco racks (US only). The brackets are sold in either individual or bulk volume kits (see "Table 12 provides the Eaton catalog part number for ordering optional and spare parts for the ePDU. Contact your local service representative for more information." on page 152).

The individual kit includes two brackets, mounting hardware (screws and KEPS nuts), and an installation diagram (see Figure 10). The same parts are provided in the bulk volume kit, but the number provided depends on how many mounting units are ordered.



NOTE In addition to the brackets and mounting hardware provided, you will use the clip feet that are provided in the ePDU shipping carton to mount the ePDU in a Cisco rack. See for "Using Mounting Brackets for Cisco Racks (US only, 52 mm Wide Vertical Models Only)" on page 35 for installation instructions.

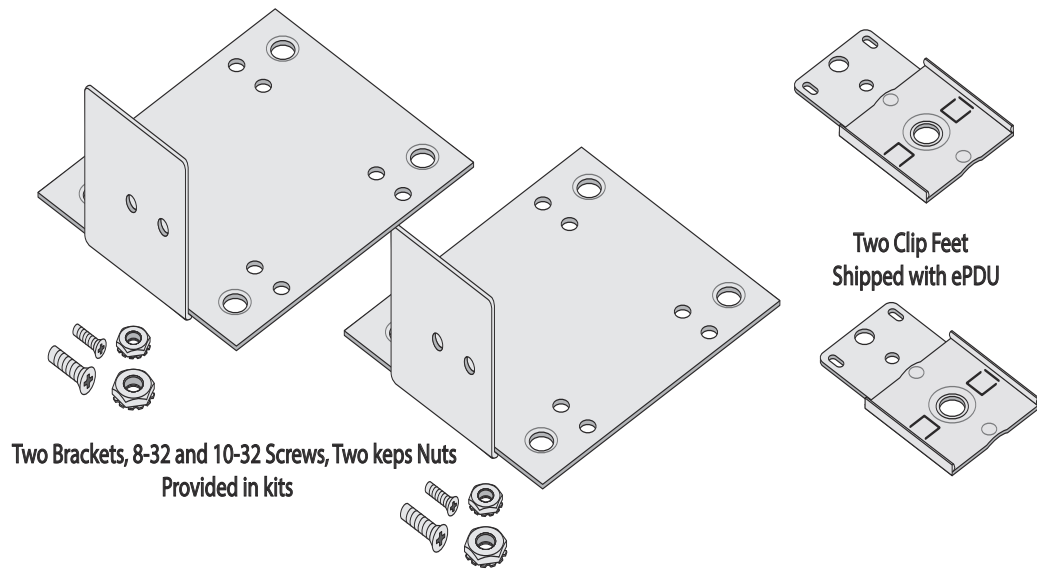

Figure 10. Mounting Bracket and Clip feet for Cisco Racks

Installation Overview



-
- NOTE 1** Power cords for the devices that you connect to the ePDU are not included.
- NOTE 2** Depending on your choice of installation method, some parts may not be used.
- NOTE 3** Use only the supplied screws for installation. Hand tighten the screws. Do not overtighten to avoid stripping the screws.
- NOTE 4** The mounting button screws are thread forming. When tightening or removing a thread forming screw initially, the fit may be tighter than usual. A thread formed aluminum hole must not be used with a different type of screw than the one used initially or it will damage the thread.
- NOTE 5** If a square-hole rack is used, cage nuts must be installed.
-



IMPORTANT

Use great care in handling the ePDU during installation. Avoid unnecessary contact between the ePDU and the rack.

Tools

The ePDU G3 is designed to be mounted without the use of tools. Mounting buttons are pre-installed on the rear of the ePDU at the factory. If you wish to use a different mounting option, such as the clip foot or side mounting, tools are not provided, but may be required as follows:

- For vertical installations:
 - Phillips cross-head screwdriver
 - Flat-blade screwdriver
 - 11/32" wrench
 - M6 cage nut insertion tool
 - T-25 TORX® driver
- For horizontal installations:
 - Phillips cross-head screwdriver
 - Flat-blade screwdriver
 - 11/32" wrench

Configurations

You can install one or two ePDUs vertically on each side of the rack (see Figure 11).

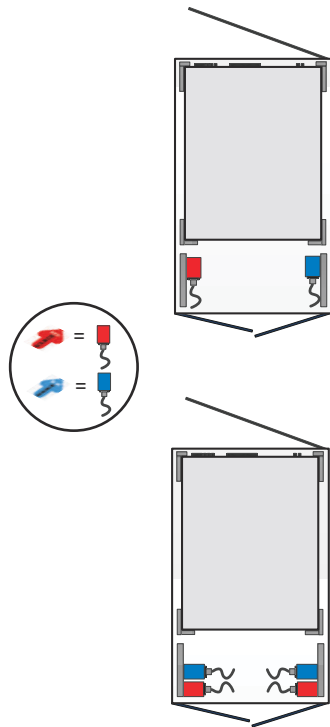

Figure 11. Vertical ePDU Configurations

You can install horizontal ePDUs in the 19-in rack space (see Figure 12).

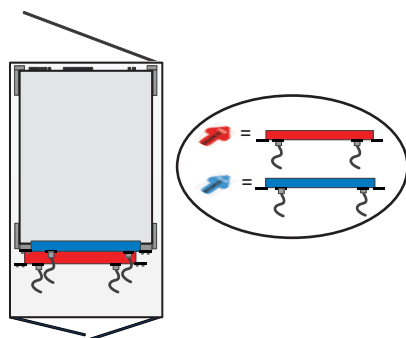

Figure 12. Horizontal Model Configurations

Power Feed Labels

Adhesive power feed labels (red power feed arrow and blue power feed arrow) are supplied to allow identification of the power flow for up to two individual ePDUs. The customer can choose the location of the sticker in an available space on the unit or the rack. Adhere one to the side of an ePDU at your discretion to indicate the power feed direction (see Figure 13).

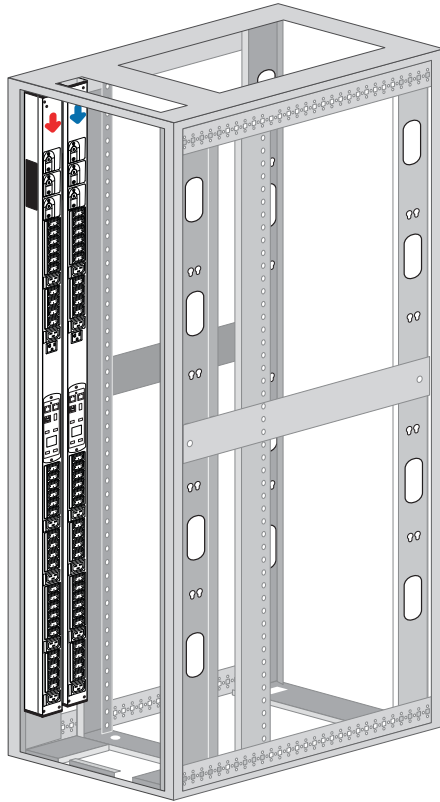

Figure 13. Power Feed Labels

Chassis Hole Pattern (EMEA models only)

The EMEA models have markings and extra holes on the back of the ePDU to accommodate different mounting requirements in EMEA racks.

You can move the ePDU up or down in the rack in 10mm intervals to ensure best fit. This standard system uses 622 mm, 933 mm, 1244 mm, 1384 mm and 1556 mm, depending on the overall length of the ePDU (see Figure 14).

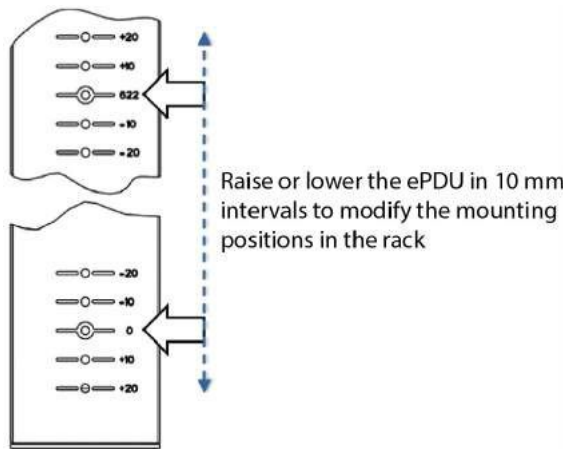

Figure 14. Raise or Lower Mounting Position in the Rack

You can also choose the appropriate distance between the keyhole buttons based on 0 value (see Figure 15).

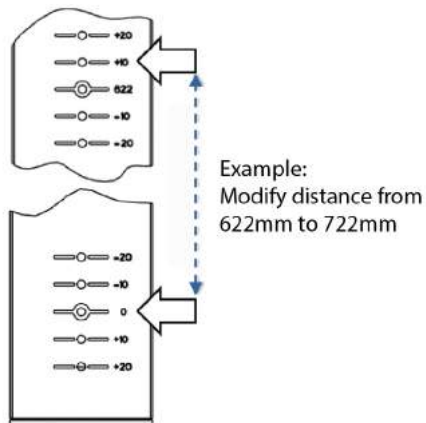

Figure 15. Change Distance Between Button Mounts for Different Racks

Mounting Buttons



NOTE Only use the provided screws to mount the buttons.

The mounting buttons for 0U vertical ePDUs are factory installed. This is a two-sided button that provides either a 2.1 mm or 2.3 mm mounting channel for a custom fit. If you discover that the rack wall is too thick or too thin and the button does not secure the ePDU, unscrew and remove the button from the ePDU. Then, flip it to the reverse side (see Figure 16). To distinguish the sides, one side is marked with a black painted ring. For EMEA models, you must not see the black ring when installed.

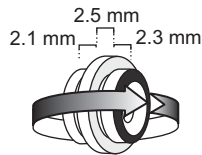

Figure 16. Reversible Factory-installed Mounting Button

Two unattached plastic mounting buttons are included in the standard hardware pack with thread-forming M4 screws and nuts for Americas, or M3 screws for EMEA (see Figure 17). These buttons provide a 3 mm mounting gap. These are supplied in case the default metal solution is not well suited to the rack. Or, you can use these when you attach mounting buttons to clip feet to install the Eaton ePDUs. Your hardware pack may also contain two additional spare M4 or M3 screws.



Figure 17. Extra Plastic Keyhole Buttons



NOTE For EMEA models, the black plastic button assembly is factory-installed in the clip feet.

IEC Outlet Grip Plug Retention Mechanism

The Eaton ePDUs have a mechanism integrated with the outlets to retain a plug inside its outlet. This system is a lever-actuated grip that prevents the plug from accidentally being bumped out or vibrating out of the outlet. It is not a locking device so the plug can still be removed in an emergency.

To operate the outlet grip plug retention mechanism:

1. Make sure the locking lever is on the “O” position before inserting the plug.
2. Plug in the power cord.
3. Gently rotate the lever to the “+” position. You should hear a “click” sound as the plug retention mechanism engages.
4. To remove the plug, gently rotate the lever to the “O” position. Remove the plug.

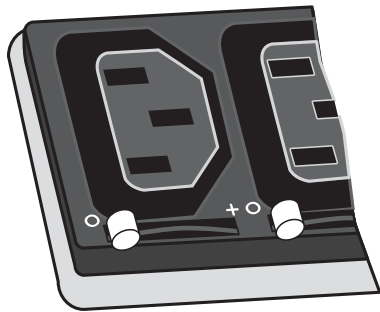

Figure 18. Plug Retention Mechanism



NOTE 1 Only unplug the power cord when the grip plug retention mechanism is in the “+” position in the event of an emergency.

NOTE 2 If you choose, you can further secure the plug with a cable tie.

Installing Vertical ePDUs in a Rack Cabinet

Regardless of the configuration you choose, there are three mounting methods available for installing the ePDU vertically in a rack cabinet:

- Using factory-installed buttons on the ePDU to mount the ePDU in keyhole openings in the rack frame
- Using buttons on clip feet to mount the ePDU in keyhole openings in the rack frame
- Using clip feet and cage nuts secured to the rack to mount the ePDU onto the clip

Review the installation methods described in this section and choose the method appropriate for your environment.



NOTE If you need to remove the ePDU from clip feet, hold on to the ePDU and use a flat screwdriver to unsnap it from the clip.

Using Factory-installed Mounting Buttons

To install the ePDU with mounting buttons directly attached to the ePDU:

1. Carefully move the ePDU into position against the rail.
2. Insert the top and bottom mounting buttons into the keyhole slots on the rack post that correspond with the position of the top and bottom mounting buttons.
3. Does the factory-installed mounting button fit flush in the rack keyhole?
 - If no, go to Step 4.
 - If yes, go to Step 5.
4. Unscrew and remove the mounting button. Turn it around 180°. Secure the mounting button to the ePDU (see Figure 19).

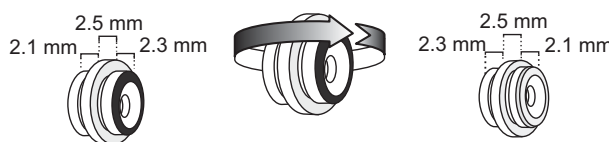

Figure 19. Reversing the Mounting Button

5. Push down to secure the ePDU in position (see Figure 20).
6. Continue to “Grounding the ePDU” on page 40 if you are installing a ground screw and grounding cable. Otherwise, go to “Network and Environmental Ports” on page 42.



NOTE

The ePDU will fit tight and it may require minor force to engage in the slot. This is a friction fit to hold the ePDU in the slot.

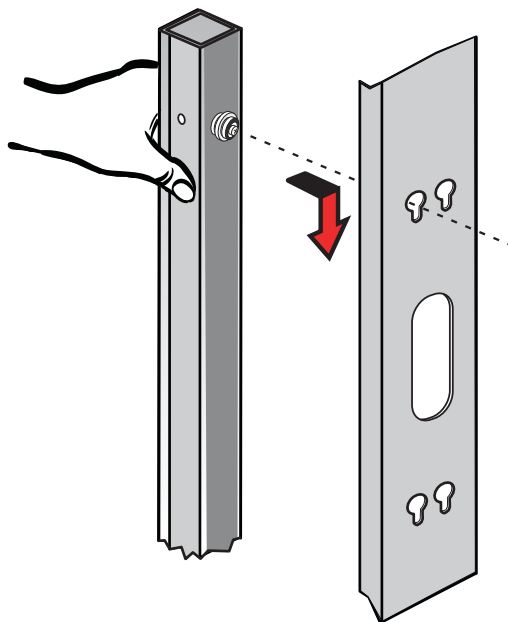

Figure 20. Securing the ePDU

Using Mounting Buttons Installed on Clip Feet (52 mm Wide Vertical Models Only)

To install the ePDU with mounting buttons installed on the mounting clip feet:

1. Locate the two mounting clip feet, M6 flathead screws, two spare plastic mounting buttons, and mounting hardware (M4 screws and M4 hex nuts, or M3 screws). Using a Phillips screwdriver, assemble the mounting buttons and clip feet (see Figure 21).

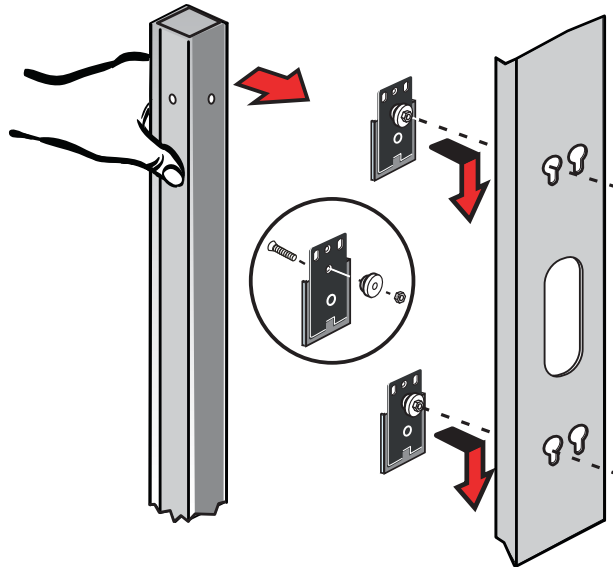

Figure 21. Attaching the Mounting Buttons to the Mounting Clip Feet



NOTE

For EMEA models, the black plastic button assembly is factory-installed in the clip feet.

2. Mount the two clip assemblies in keyholes spread far enough apart to stabilize the top and bottom of the ePDU when mounted on the rail. See “Chassis Hole Pattern (EMEA models only)” on page 29 for more information.
3. Carefully move the ePDU into position against the rail.
4. Snap the clip feet onto the ePDU at the desired vertical position.
5. Align the clip feet and slide the mounting button into the keyhole slots.
6. Push down to make sure the ePDU is secured into position.
7. Continue to “Grounding the ePDU” on page 40 if you are installing a ground screw and grounding cable. Otherwise, go to “Network and Environmental Ports” on page 42.

Using Clip Feet and Cage Nuts on a Square-hole Rack

i NOTE You can install the mounting clip feet vertically or horizontally.

i NOTE If a square-hole rack is used, cage nuts must be installed. Use a cage nut insertion tool or a flat-blade screwdriver to install the cage nuts.

To install the ePDU with clip feet secured by cage nuts:

1. Locate the cage nuts (supplied).
2. Are you mounting the ePDU in line with the rail or away from the rail (offset)?
 - If in line with the rail, go to Step 3.
 - If away from the rail, go to Step 6.
3. **ePDU in line with the rail.** Position and lock two cage nuts far enough apart to stabilize the top and bottom of the ePDU when mounted on the rail. Insert the cage nuts with a flat-blade screwdriver (see Figure 22).
4. **Americas Models Only:** Locate the two clip feet and four M6 screws (supplied). Position one mounting clip foot at a cage nut and secure the mounting clip foot to the rail with a screw. Repeat for the second mounting clip. Tighten the screws. Go to Step 9.
5. **EMEA Models Only:** Using two clip feet (supplied) and use flat-head M6 countersunk screws (not supplied), position one mounting clip foot at a cage nut and secure the mounting clip foot to the rail with a screw. Repeat for the second mounting clip. Tighten the screws. Go to Step 9.

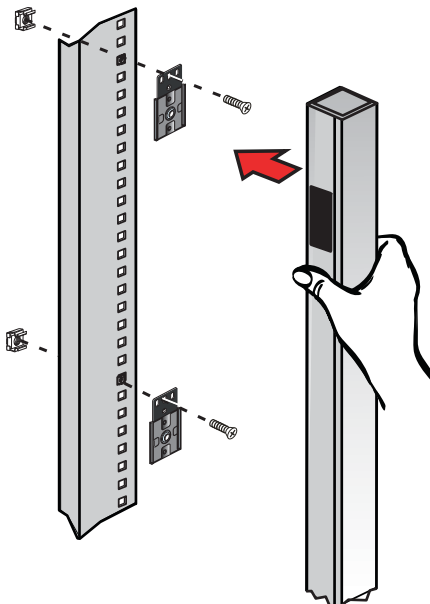

Figure 22. Attaching the Clip Feet and Cage Nuts

6. **ePDU away from the rail (offset).** Position and lock two cage nuts far enough apart to stabilize the top and bottom of the ePDU when mounted on the rail. Insert the cage nuts into the square rail hole with a flat-blade screwdriver.
7. Locate the two clip feet and four M6 screws (supplied). Turn the straight part of the bracket 90° (see Figure 23).
8. Position one mounting clip foot at a cage nut and secure the mounting clip foot to the rail with a screw. Repeat for the second mounting clip. Tighten the screws.

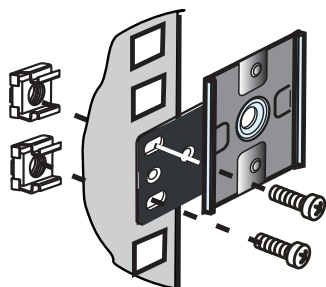

Figure 23. Attaching the Rotated Clip to the Rail

9. Snap the ePDU into the mounting clip feet. When you hear a clicking sound for each mounting clip foot, the ePDU is secure.
10. Continue to “Grounding the ePDU” on page 40 if you are installing a ground screw and grounding cable. Otherwise, go to “Network and Environmental Ports” on page 42.

Using Mounting Brackets for Cisco Racks (US only, 52 mm Wide Vertical Models Only)

To install the ePDU in a Cisco rack using mounting brackets:

1. For each ePDU you will install, locate two mounting brackets with screws and keps nuts, and two clip feet.
2. Decide the orientation in which you will mount the ePDU or ePDUs and install the clip feet to the bracket as illustrated in the following figures:
 - **One ePDU or Side-by-side inboard.** Outlets facing toward the other side of the rack, go to Figure 24 on page 36.
 - **Multiple (up to four) 904 mm ePDUs inboard.** Outlets facing toward the other side of the rack, go to Figure 25 on page 37.
 - **One ePDU rearward.** Outlets facing out the back of the rack, go to Figure 26 on page 38.
3. Position the brackets to align with the top, upper, lower, and/or bottom mounting rail.



NOTE

Mount the bracket with the clip feet facing up for upper and top rail installation. Mount the bracket with the clip feet facing down for lower and bottom rail installation.

For One or Two Side-by-Side G3 ePDUs

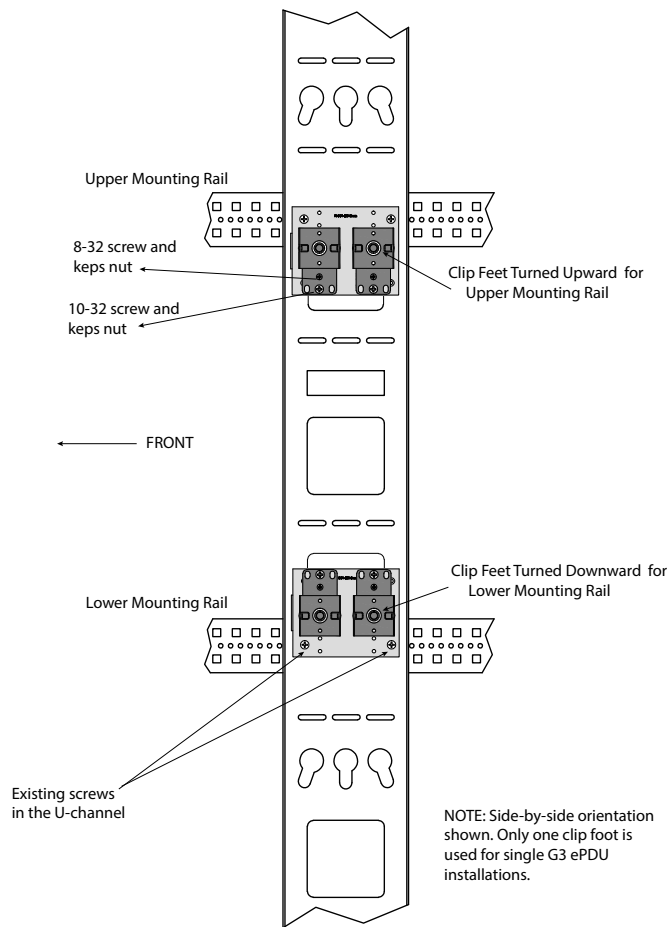

Figure 24. Single or Side-by-Side Inboard



NOTE

You can also configure up to four 902 mm (35.5 in) ePDUs on a rail, with up to two ePDUs secured by brackets on the top and upper mounting rail, and up to two ePDUs secured by brackets on the lower and bottom mounting rails.

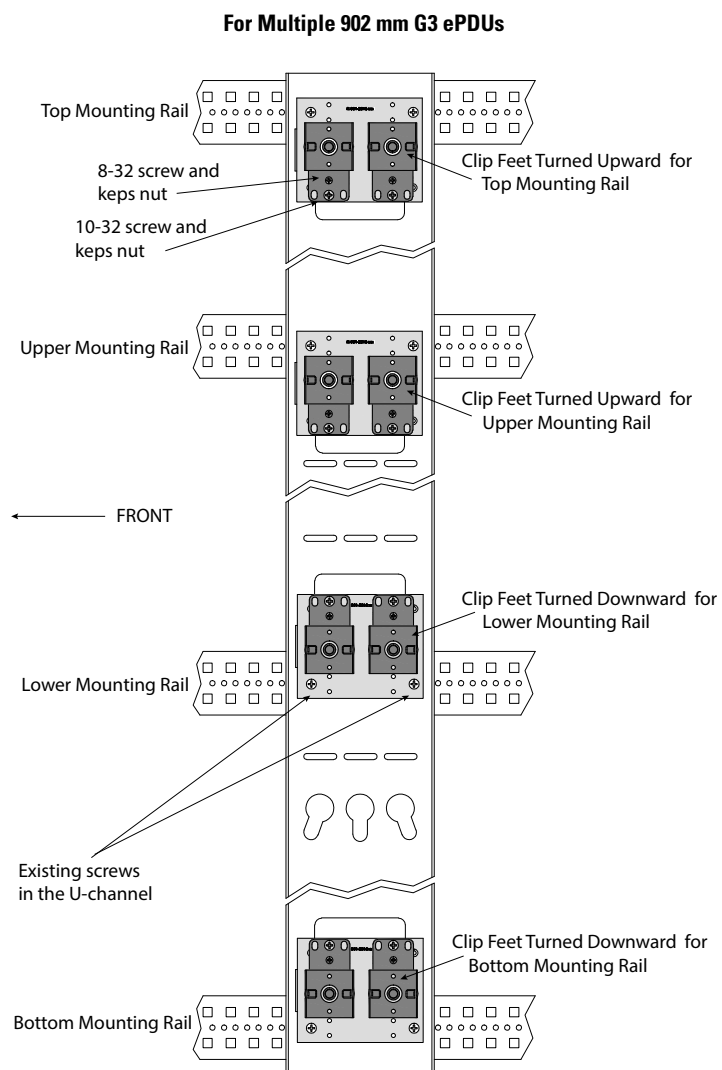

Figure 25. Multiple 902 mm Inboard

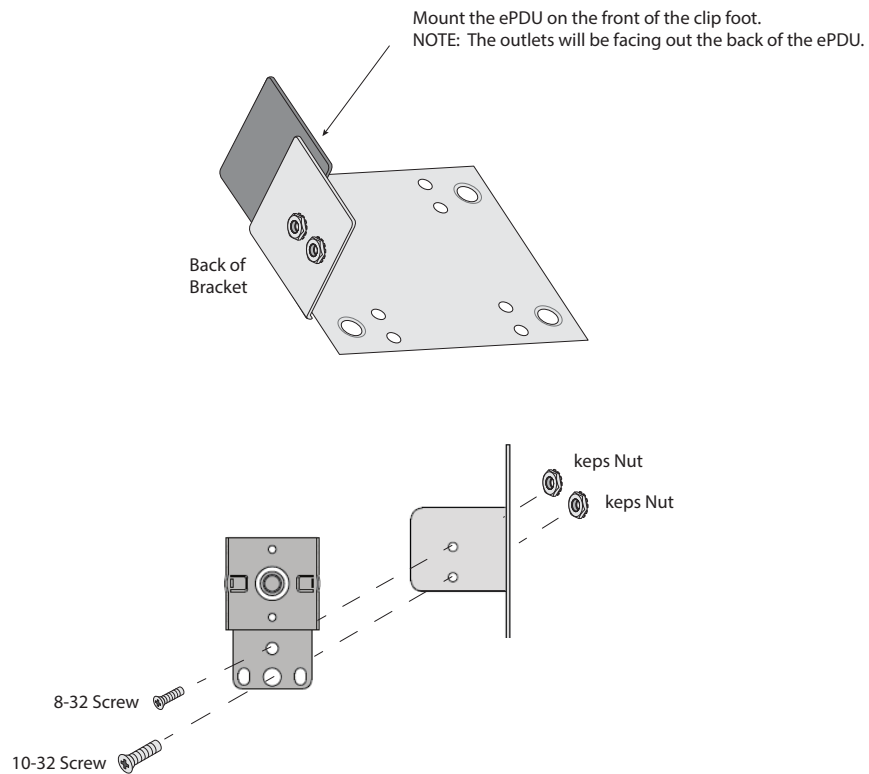

Figure 26. Single Rearward

4. Remove the existing screws in the holes where you want to position the bracket in the U-Channel rail.
5. Align the bracket screw holes with the U-Channel screw holes and secure the bracket (with clip feet installed) to the rack rail with the U-Channel screws.
6. Repeat for the second bracket.
7. Snap the ePDU into the mounting clip feet. When you hear a clicking sound for each mounting clip foot, the ePDU is secure.
8. Continue to "Grounding the ePDU" on page 40 if you are installing a ground screw and grounding cable. Otherwise, go to "Network and Environmental Ports" on page 42.

Installing the Horizontal Models in a Rack Cabinet



NOTE For horizontal installations in square-hole racks, a cage nut must be installed in the selected mounting holes.

To install the ePDU models horizontally:

1. Select the desired height position to install the ePDU.



NOTE 1 The two black mounting brackets are pre-installed on the unit.

NOTE 2 Make sure to select mounting holes that are parallel to each other so that the ePDU will be level when installed.

2. **For square-hole racks.** Install cage nuts in the appropriate mounting holes. Insert and tighten two M6 screws through the ears on each side of the ePDU.
3. **For all other racks.** Insert and tighten two M6 screws through the ears on each side of the ePDU (see Figure 27).

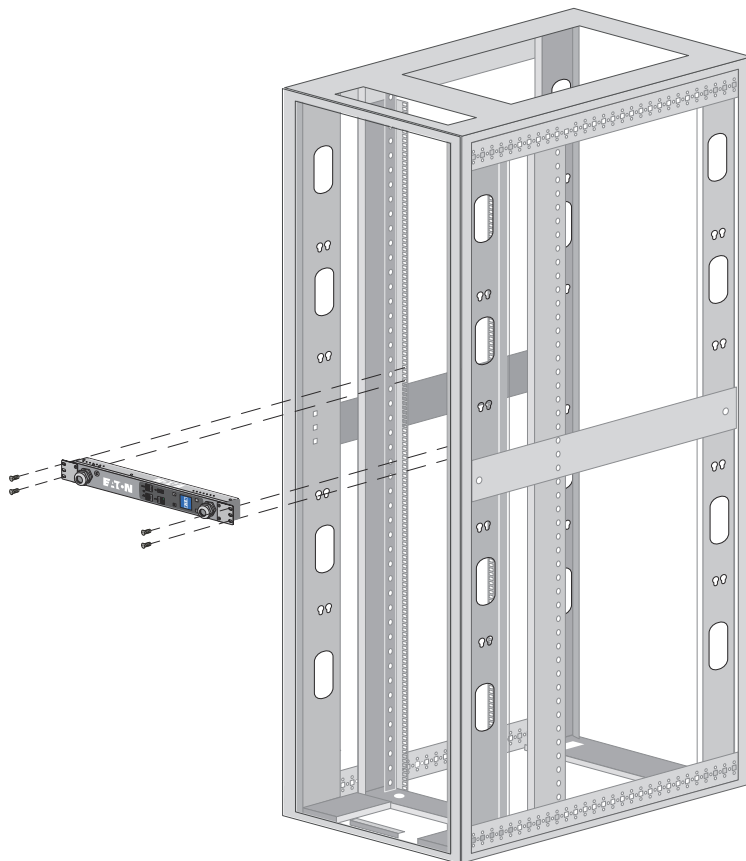

Figure 27. Installing Horizontal Models

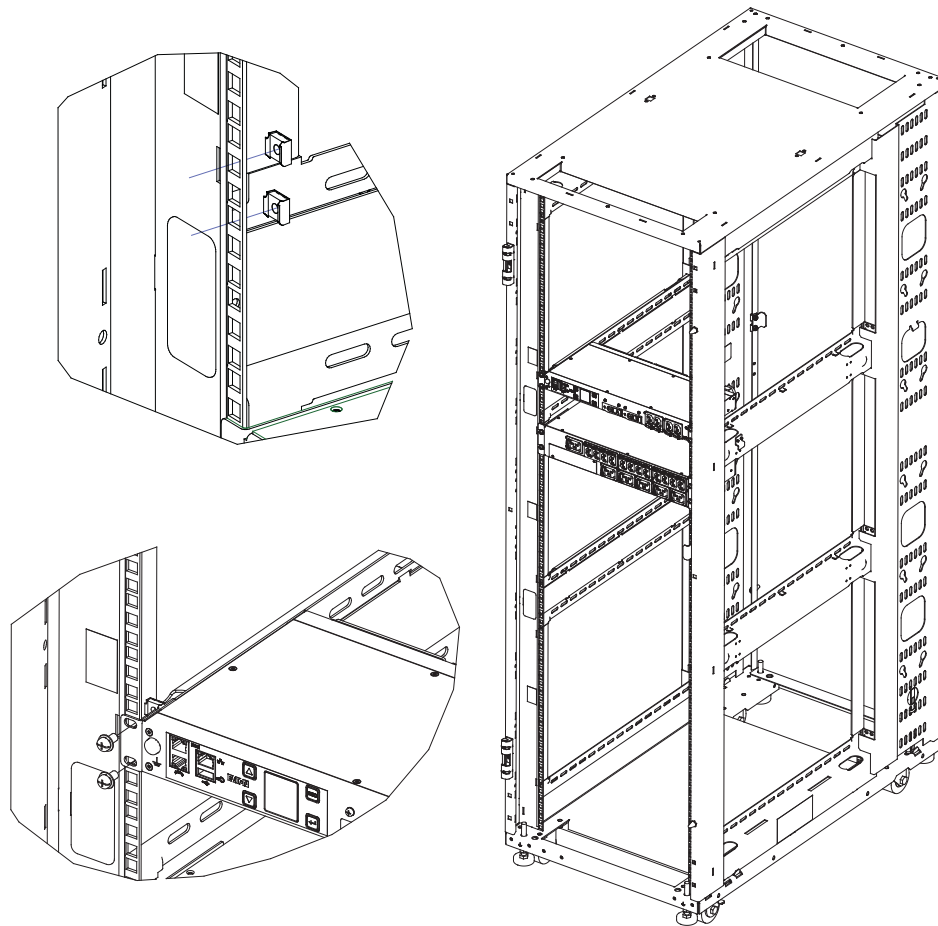

Figure 28. Installing 1U/2U Models

4. Continue to “Grounding the ePDU” if you are installing a ground screw and grounding cable. Otherwise, go to “Network and Environmental Ports” on page 42.

Grounding the ePDU



NOTE Grounding the ePDU is optional but recommended.

The ePDU is grounded through the input plug and an M6 ground screw is provided for auxiliary rack grounding. Conductors can be connected to the ground screw for functional grounding or bonding of ungrounded metal parts within the rack. The grounding screw is sized to safely conduct the fault current of the single largest output breaker. There is no paint on the screw or the chassis surface to ensure contact with bare metal instead of a painted surface. The ground symbol is impressed in the chassis above the earth bonding screw.

To ground the ePDU, connect a grounding cable (not supplied) from earth to the grounding screw shown in Figure 29 through Figure 31. The internal diameter of the ground strap ring is M6 (6 mm).

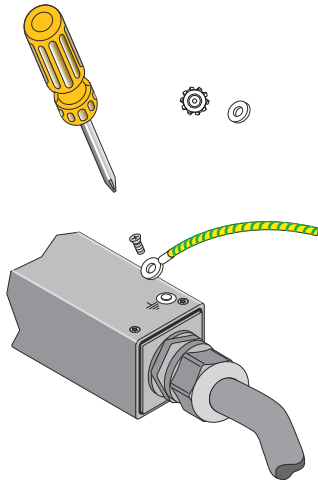

Figure 29. Grounding Screw Location for 0U Vertical Models

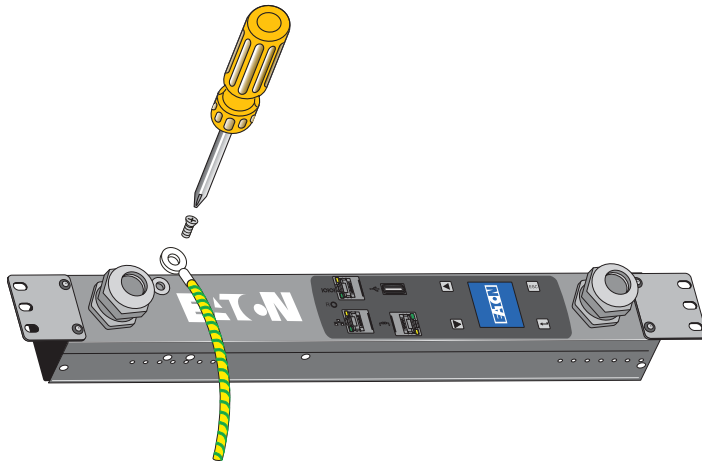

Figure 30. Grounding Screw Location for 1L Horizontal Models

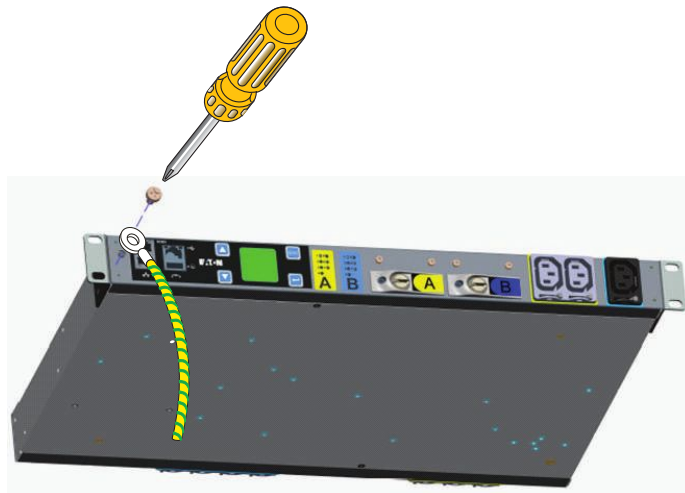

Figure 31. Grounding Screw Location for 1U Models

Network and Environmental Ports

The ePDU provides four types of ports for network connectivity and environmental sensor monitoring.

- To connect the ePDU to a serial port on a computer, go to the next section, “Connecting to a Computer Serial Port”.
- To connect the ePDU to a 10/100 MB Ethernet-capable port and the Local Area Network (LAN), go to “Connecting to a LAN Ethernet Port” on page 43.
- To daisy-chain ePDUs, go to “Connecting Multiple ePDUs in a Daisy Chain” on page 43.
- To connect the ePDU to EMP equipment, go to “Connecting Optional Environmental Monitoring Probe Equipment” on page 45.

Connecting to a Computer Serial Port

Connecting the ePDU to a computer allows communication through a serial connection.

To connect the ePDU to a computer:

1. Verify that the computer has a communication program such as HyperTerminal, Telnet, or SSH.
2. Locate the DB9-to-RJ-45 cable (supplied).
3. Connect the RJ-45 end of the cable to the RS-232 connector on the front panel of your ePDU model (see Figure 32). Connect the DB9 end of the cable to the serial connector on the computer.

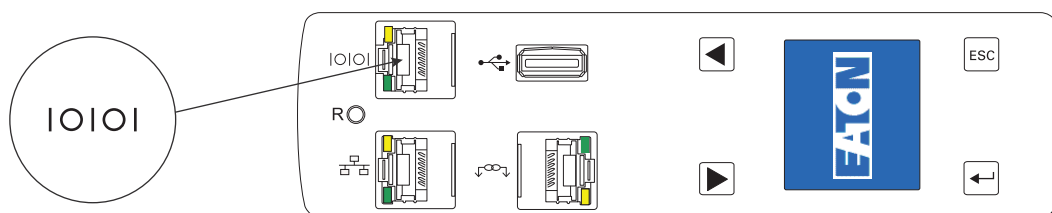

Figure 32. Connecting to a Computer Serial Port (OU Models)



NOTE

If your computer does not have a DB9 serial connector, obtain a DB9-to-USB converter. Follow the manufacturer’s instructions to install the converter cable device drivers and to connect the converter cable to your computer.

Connecting to a LAN Ethernet Port

Connecting the ePDU to a LAN provides communication through an Internet or Intranet connection. You can monitor the ePDU from any computer connected to the same network. (The network card is 10/100 MB-compatible.)

To connect the ePDU to a LAN:

1. Locate the Ethernet cable (supplied).



NOTE A short network cable is supplied in the network accessory pack. This cable is useful for setup or can be used where the network switch is in close proximity to the ePDU. Any standard network cable can be used if longer lengths are needed.

2. Connect one end of the cable to the Ethernet connector on the ePDU (see Figure 33). Connect the other end of the cable to the Ethernet connector on the router (or other LAN device).

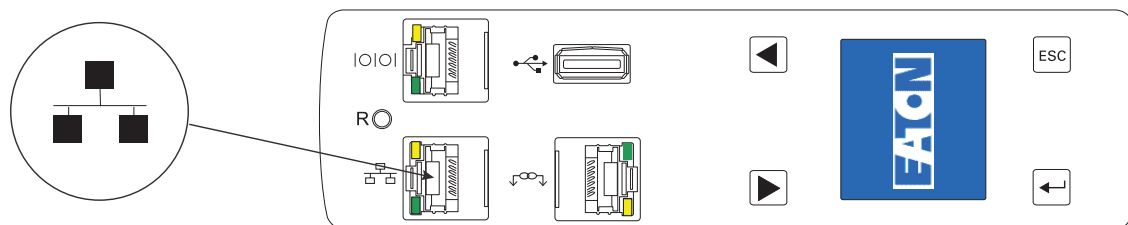

Figure 33. Connecting the ePDU to a LAN (0U Models)

Connecting Multiple ePDUs in a Daisy Chain

Two to eight ePDUs can be chained together using an Ethernet cable between the Daisy-Chain ports located on the front panel. Daisy chain uses Eaton's patented RS-485 daisy chain (strapping) technology. This allows access to the ePDU data of multiple ePDUs from the same network connection. One ePDU is defined as the Host. This is the ePDU with a connection to the network. The other ePDU (or ePDUs) are Device(s).



NOTE You should connect the daisy-chained group only to the ePDU defined as the Host.

To physically connect ePDUs in a Daisy Chain:

1. Locate an Ethernet cable or cables (one cable is supplied).

NOTE When daisy-chaining ePDUs, observe the following:



- For two ePDUs, you do not need a splitter.
- For three or more ePDUs, you use Y splitters.
- The maximum distance between units is 5m (16 ft). For example, when connecting one host and seven devices, this means that the total maximum distance between the first and last ePDUs is 35m (115 ft).

2. How many ePDUs are you daisy-chaining?
 - If daisy-chaining two ePDUs (1+1), go to Step 3
 - If daisy-chaining three ePDUs or more (2+1 to 7+1), go to Step 5
3. Connect one end of the cable to the Daisy Chain connector on one ePDU. Connect the other end of the cable to the Daisy Chain connector on the other ePDU as shown in Figure 34.
4. Go to Step 7 to configure the daisy-chained ePDUs.

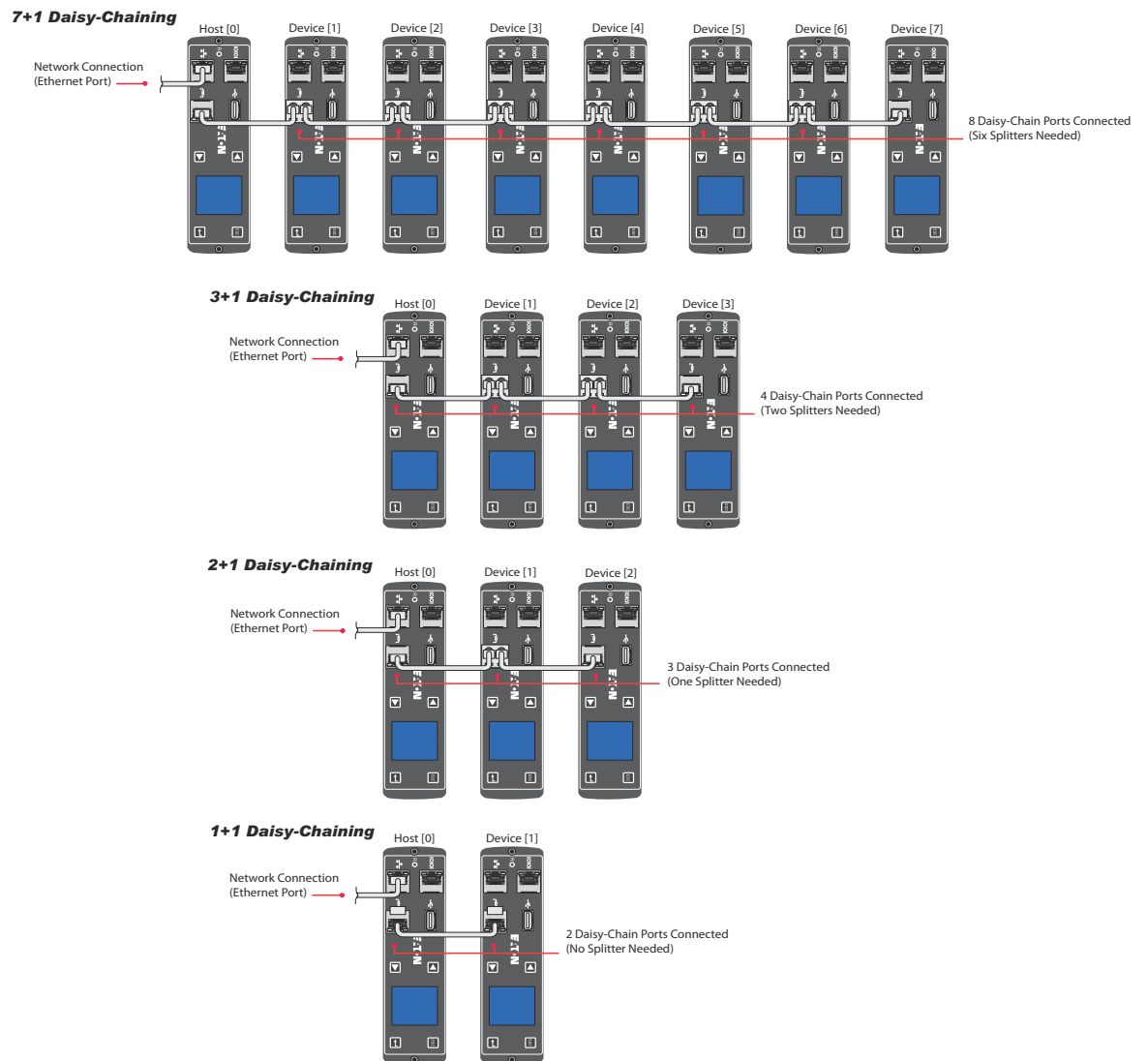

Figure 34. Locating the Daisy Chain Connector

5. Insert a Y splitter in the Daisy Chain connector for all ePDUs between the Host and the last ePDU in the chain, as shown in Figure 34 and Figure 35.
6. Go to Step 7 to configure the daisy-chained ePDUs.

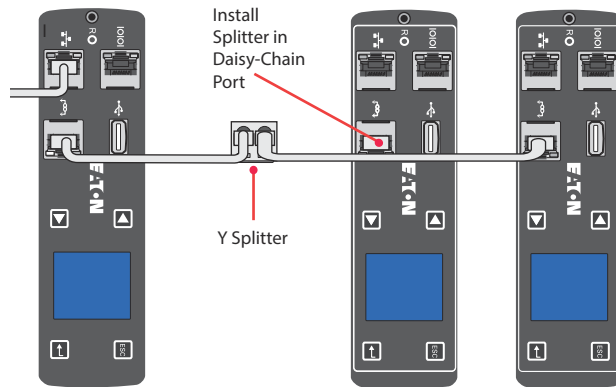

Figure 35. Y Splitter in Daisy-Chain Port (2+1 Daisy-chaining Shown)

7. Choose to configure the ePDUs with either the LCD interface or the CLI interface:
 - To configure the ePDUs using the LCD interface, go to “Daisy Chain Submenu” on page 77.
 - To configure the ePDUs using the CLI interface, go to “Set Daisy Chain” on page 90.

NOTE You can monitor the ePDUs with either the CLI interface or the Web interface.



- To monitor the ePDUs using the Web interface, go to “Web Interface Operation” on page 92.
- To monitor the ePDUs using the CLI interface, go to “Get Daisy-chained ePDU to Supervise or Retrieve Communication Status” on page 88 in the CLI Interface chapter.

Connecting Optional Environmental Monitoring Probe Equipment

You can purchase optional EMP equipment to monitor temperature and humidity around the ePDU and to monitor the status of sensors.

You can install an optional EMP now or after completing the ePDU installation and startup. Optional EMP equipment can be installed without turning off power to the ePDU or the devices connected to it.



IMPORTANT

Follow all installation and operation safety information provided in the manufacturer’s instruction manual for the EMP equipment.

To install an optional EMP:

1. Locate the EMP and the Ethernet cable (supplied).
2. Refer to the manufacturer’s installation manual for instructions to connect the external contact inputs to the optional EMP for the external contact devices you plan to monitor.
3. Locate the Ethernet cable dedicated to the EMP. Connect one end of the cable to the RJ-45 connector on the EMP, then connect the other end of the cable to the serial connector on the ePDU (see Figure 36).

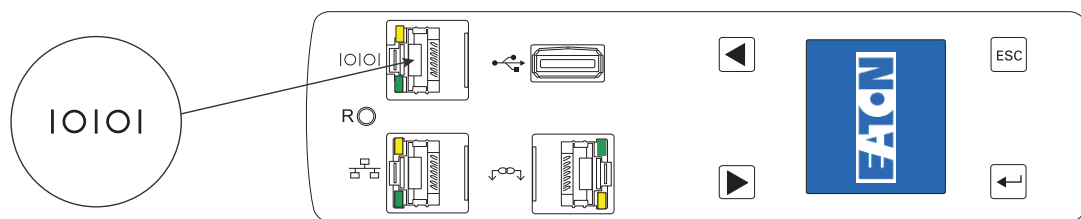

Figure 36. Connecting the EMP to the ePDU RJ-45 Serial Port Connector (OU Models)



NOTE If you install an EMP, the ePDU serial port must be dedicated to the EMP.

4. Use the mounting method appropriate to your installation to mount the EMP in a convenient location anywhere on the rack.
5. If desired, use cable ties to secure the Ethernet cable out of the way as needed.
6. On startup, the ePDU automatically recognizes the EMP.

Connecting the Output Devices

The ePDU outlets are available for connecting and monitoring devices such as workstations, servers, and switches. Connect a device you want to monitor to a power outlet on the ePDU with the power cord that comes with the device.



NOTE You may find it useful to document the connections you make.

To connect your devices:

1. Verify that each circuit breaker is in the On position.
2. **For ePDUs with detachable power cords.** If the power cord is not connected, connect the power cord to the ePDU. Otherwise, go to Step 3.
3. Route the ePDU power cord toward a dedicated power source. If desired, use cable ties to secure the power cord as needed. If the power cord must exit the rack cabinet to connect to a power source, use the openings in the rack cabinet.



NOTE 1 Plug the ePDU into an appropriately rated outlet for its type.

NOTE 2 Do not replace or rewire the power cord.

4. Connect the power cord to a properly wired and grounded dedicated power source. The ePDU turns on and displays the Eaton startup screen while starting. After five seconds, the sequence of LCD screensaver screens for this ePDU model begin cycling.
5. Verify that no alarms display on the LCD. To resolve alarms, see "Maintenance and Alarms" on page 135.

6. If your model uses grip plug retention levers on the outlet plugs, make the lever in the “O” position before inserting the plug.
7. Connect your output devices to the outlet outlets on the ePDU. Verify that each device is receiving power before connecting the next device.



NOTE To avoid large surge currents, connect the protected equipment to the outlets individually rather than as a group. You may want to include a delay for Switched and Managed models when setting up groups of outlets to start at the same time to avoid a large in-rush current.

8. If your model uses grip plug retention levers, gently rotate the lever to the “+” position. You should hear a “click” sound as the mechanism engages.



NOTE Only unplug the power cord when the grip plug retention mechanism is in the “+” position in an emergency. To remove the plug, gently rotate the lever to the “O” position and remove the plug.

9. Route all power cords neatly. If desired, use cable ties to secure the cords.

Operating the ePDU

See “Operation Overview” on page 48 for instructions to operate the ePDU, including starting and shutting down the equipment.

Chapter 4 Operation Overview

This chapter describes the Eaton Enclosure Power Distribution Unit (ePDU) G3 operation overview.

Operation Interfaces

The type of model you are using dictates the level of ePDU operation control you have. You can configure, manage, or monitor the ePDU through a local interface (onboard the ePDU) or through remote interfaces (through the network):

- **Configure (All except Basic).** Basic configuration is available for some settings through the LCD menu onboard the ePDU. Full configuration of all settings is available through the remote Web and Command Language Interpreter (CLI) interfaces.
- **Monitor (All except Basic).** You can monitor measurements using either the local or Web remote interfaces.
- **Manage (For Switched (SW) and Managed (MA) ePDUs only).** You can use the Web interface to monitor the ePDU and manage outlets and groups of outlets. Outlets that are in the same user-defined group can be turned on, turned off, rebooted, and scheduled to perform actions in a synchronized manner.

Local Operation Interface

The LCD provides information about the ePDU and connected devices using white text on a blue background. The LCD display flashes red when any alarm is active.

The LCD display orientation can be changed using an LCD or CLI setting. The display can be rotated 90°, 180°, or -90° (270°). See "Display Submenu" on page 76 or see Example 2 in "set command" on page 88 for more information.

LCD Display

The LCD display has three modes:

- **Screensaver Mode** (startup screen)

Screensaver mode cycles through a set sequence of screens that display current PDU values. Current values are refreshed every five seconds. The user cannot select a custom sequence of screens.
- **Energy Saving Mode**

This mode is activated manually. The backlight is turned off to conserve energy. The screen darkens. The screen reactivates when any button is pushed or when an active alarm occurs.
- **LCD Main Menu Mode**

The settings that display under each high level (main) menu depend on your ePDU model.

Status Display

When the screensaver is activated, it displays a set of up-to-date values. However, this set of values is not user-configurable. To selectively view values, navigate through the LCD interface using the buttons on the front panel.

For example, selecting ePDU from the Meter submenu and then selecting Total Input from the ePDU Meter submenu displays total input values for the ePDU. Figure 37 is an example of the display for a 1Ph ePDU.

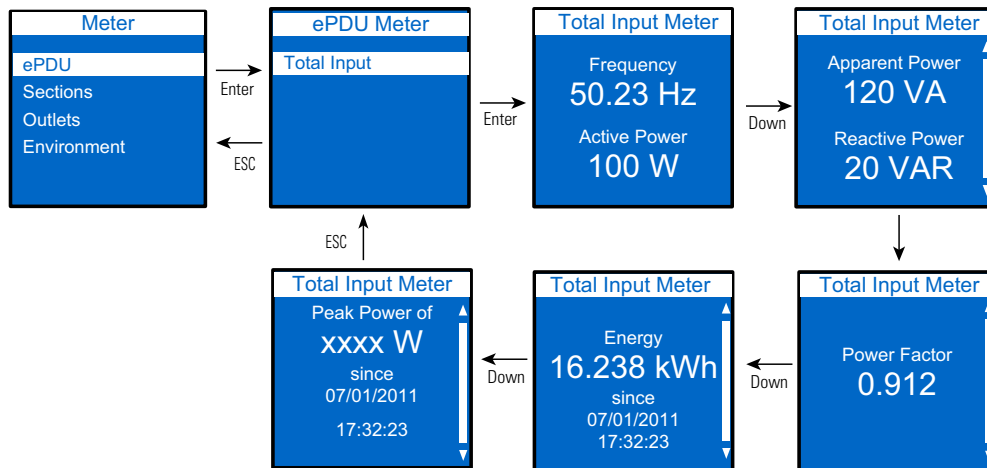

Figure 37. Example of Selected Value Display

Main Menu Display

The menu items are highlighted when they are selected. The resulting screens can include data displays, value setting options, or submenus. Figure 38 illustrates the highlighted Active Alarms LCD menu item selection.

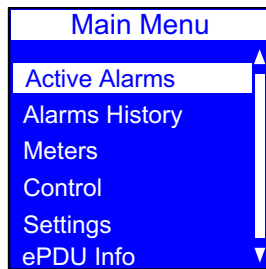

Figure 38. Menu Item Selection

See “LCD Interface Operation” on page 60 for detailed operation information.

Remote Operation Interfaces

You can communicate with the ePDU using the remote interfaces listed in Table 3.

Table 3. Remote Interfaces

Interface	Description	ePDU Connector	Cable (supplied)	Cabling Instructions
Web browser	ePDU management interface through an Internet Web browser*			
SNMP	Standard Internet protocol for managing devices on networks**	Ethernet connector	Ethernet cable	"Connecting to a LAN Ethernet Port" on page 43
Telnet Command Line Interface (CLI)	Terminal emulation protocol for accessing the CLI via Ethernet to configure the eNMC module			
Console emulator CLI	Serial interface for accessing CLI directly from a computer	Serial connector ***	DB9-to-RJ-45 cable	"Connecting to a Computer Serial Port" on page 42

* Supports Microsoft® Internet Explorer® 8.0 and greater, Mozilla® Firefox®, Google Chrome™.

** Supports Simple Network Management Protocol (SNMP) v1, v2, and v3. Provides the ability to send traps, retrieve outlet specific data, set ePDU and outlet values, and notify of events through SNMP trap or e-mail alert.

*** If you install an optional EMP, you must dedicate the serial connector to the EMP. (The EMP Ethernet cable is supplied in the EMP shipping carton.)

Outlets and Circuit Breakers

A variety of outlet types are available for the Eaton ePDUs. Each ePDU model has a specific configuration of outlets. The configuration can be standard or customized to suit your needs.

The outlets are grouped in sets called sections. Sections are preset groups of individual outlets that you can identify and monitor through the interfaces that are available with your particular type of ePDU.

The outlets are color-coded and labeled, and if the model has circuit breakers, the circuit breakers that are associated with the outlets have corresponding labels (see Figure 39). (The "circuit breaker tripped" status is not reported.)

Outlets and sections of outlets can be managed through the Web Interface (see "Outlets" on page 110, "Outlets" on page 110, and "System" on page 119). You can see measurement readings using the local LCD interface.

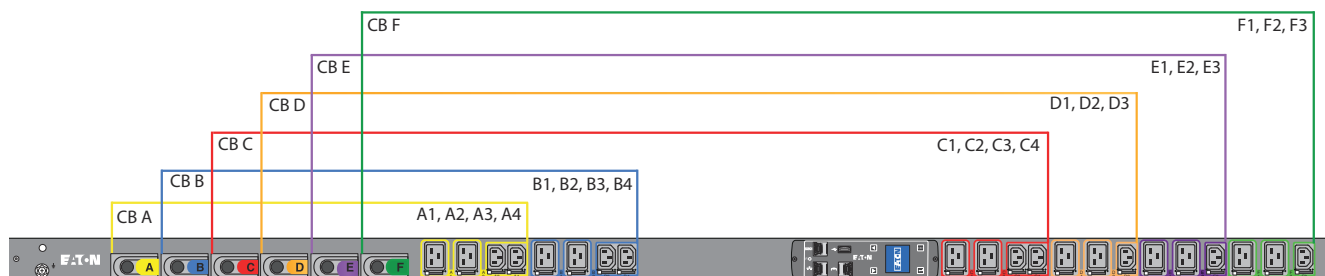

Figure 39. Outlet Groups and Circuit Breakers

Ports, Operation Buttons, and LED Status Indicators

The Eaton ePDUs include communication and serial ports (also used for environmental sensor monitoring), operation buttons, and status LEDs (see Figure 40). The ePDU front panel includes communication and monitoring ports, LED status indicators, and operation buttons. The ports and the associated LED indicators are described in the following Table 4.

NOTE At startup, check the LED status display colors on the communication and monitoring ports to ensure that they are operating correctly.

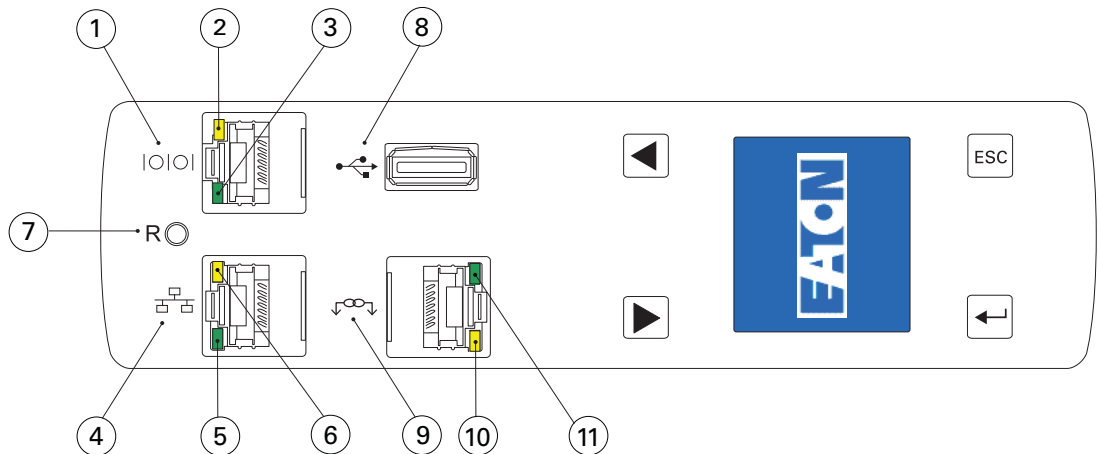

Figure 40. Communication and Serial Ports (0U Models)

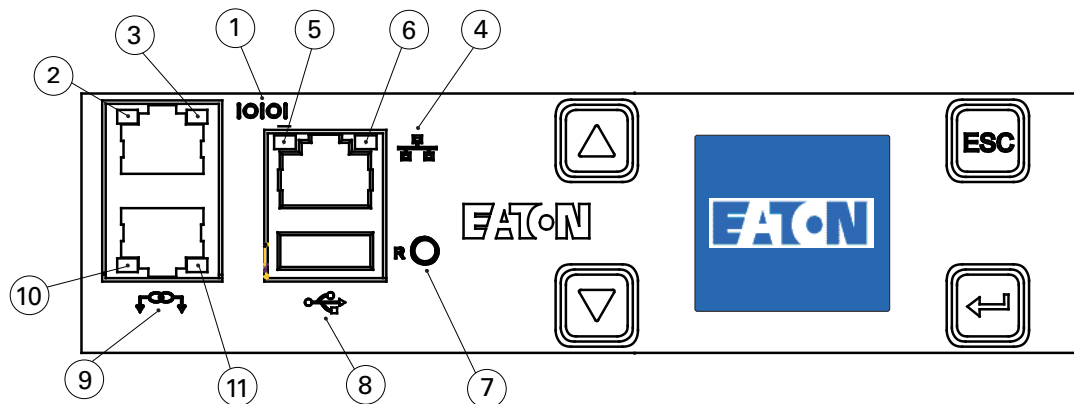

Figure 41. Communication and Serial Ports (1U and 2U Models)

Table 4. Communication and Environmental Sensor Monitoring Ports

Diagram Reference Number	Description
1	Serial or Environmental Sensor Monitoring (EMP) Port
2	Yellow Serial/EMP Port LED: RS-232 Operation and Activity Status OFF: No EMP connected FLASHING: EMP connected
3	Green Serial/EMP Port LED: ePDU Communication Status OFF: ePDU start-up in progress FLASHING: eNMC module operational
4	Ethernet 10/100 Base-T Port
5	Green Ethernet Port LED: Operation Transfer Rate Status OFF: Port operating at 10 Mbits/s ON: Port operating at 100 Mbits/s
6	Yellow Ethernet Port LED: Connection and Transmission Activity Status OFF: ePDU not connected to the network ON: ePDU connected to the network, but no activity FLASHING: Port is sending or receiving (transmission active)
7	Reset Button NOTE To restart the eNMC, insert a probe and press the button for 3 seconds (or until the LCD goes blank). This does not reset power to the outlets.
8	USB Port: Used for firmware upgrade and configuration file download/upload
9	Daisy-Chain Port
10	Yellow Daisy-Chain Port LED: Transmission Activity Status FLASHING: ePDU is transmitting data
11	Green Daisy-Chain Port LED: Role Assignment in Communication Protocol ON: Device FLASHING: Host

Operation Concepts

This section provides information describing the following ePDU operation concept:

- User login and access policy

For more information, see “Access Privileges” on page 98.

User Login and Access Policy

The web interface is protected by a login and a password. The ePDU Network Management and Control (eNMC) module manages up to eight users and one Administrator.

A user is defined by:

- Name identifier (login)
- Password (minimum of five characters)
- Assigned access rights (Read Only, Read/Write, Read/Write/Control, No Access)
- List of groups of outlets to which the user has access



NOTE

At a minimum, users need Read-Only access rights to access the Web pages.

When a user accesses the Web interface, the system prompts for a login and password. The login and password for the administrator and for each user are hashed using a one-way hash algorithm. If the login and password match and the assigned user rights do not restrict access, the user can access the Web interface.



IMPORTANT

Users should always terminate sessions by clicking the logout link in the top right-hand corner of the Web interface page.

Common Operations

Starting the ePDU



NOTE The Eaton ePDUs have no power switch.

To start up the ePDU:

1. For ePDUs with detachable power cords: If the power cord is not connected, connect the power cord to the ePDU, then connect the power cord to a power source. Otherwise, go to Step 2.



NOTE 1 Plug the ePDU into an appropriately rated outlet for its type.

NOTE 2 Do not replace or rewire the power cord.

2. Verify all circuit breakers are in the On position.



IMPORTANT

To power cycle the Eaton ePDU, remove the power cord from the power source and then plug it back in.

Shutting Down the ePDU

To shut down the ePDU:

1. Shut down the connected devices according to the manufacturer's recommended shutdown sequence.
2. Turn each circuit breaker to the Off position.
3. To remove power from the ePDU completely, disconnect the ePDU power cord from the power source.

Restarting the ePDU Network Management and Control (eNMC) module

You can restart the communications module using either a hardware or software method.



IMPORTANT

Restarting the eNMC module will not affect the output power or the connected equipment.

A software restart is triggered from the Serial interface or Web interface upon user action (see Figure 42). This method is typically the better choice because all current settings in the communications module file system are saved before restarting.

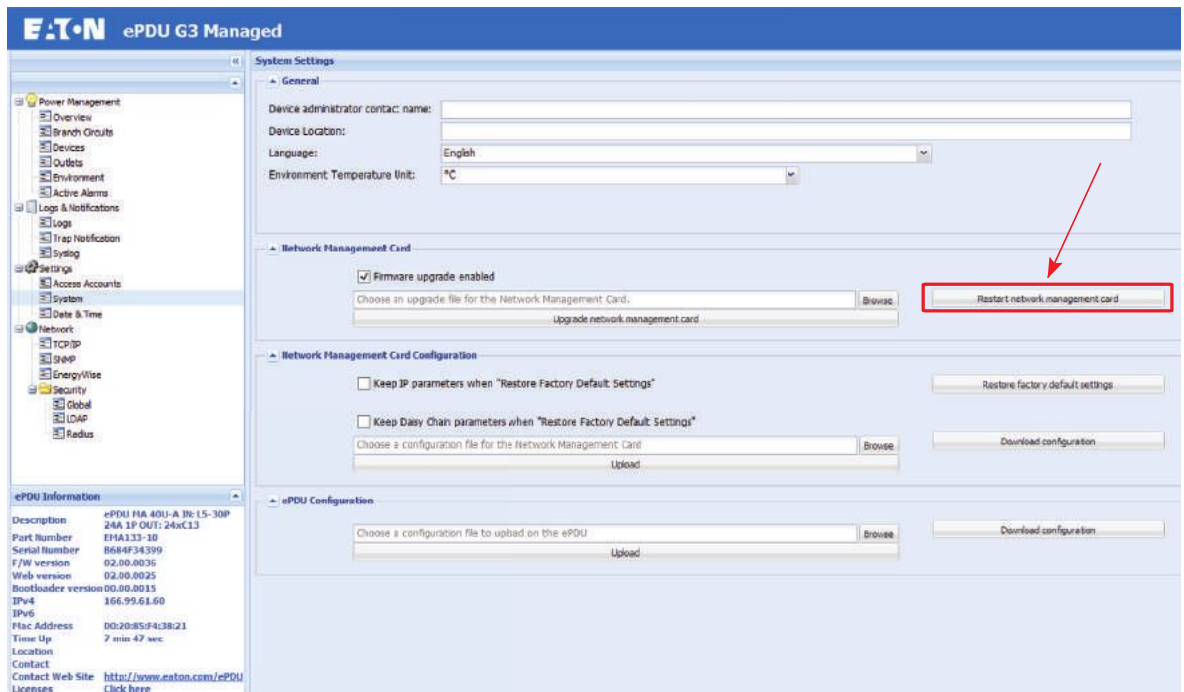

Figure 42. Reset the eNMC Module from the Web Interface

For a hardware restart, locate the Reset opening (labeled R) on the ePDU (see Figure 43). Insert a probe, press the recessed button, and retract the probe. This method is not necessarily the best choice because the communications module does not force the system to save the parameters in the file system before restarting.

The H/W restart button does not affect ePDU outlet status. The energy consumption is still recorded during the reboot of the eNMC module.



NOTE

When using a hardware restart to restart the eNMC module, there is no mandatory check to ensure that the file system parameters are saved before restarting.

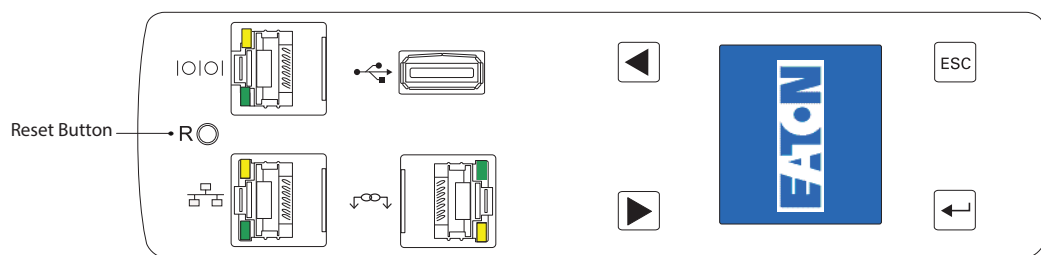

Figure 43. Reset Button (OU Models)

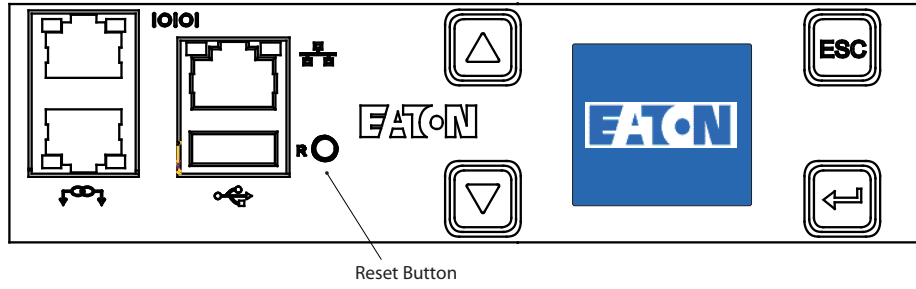

Figure 44. Reset Button (1U and 2U Models)

Chapter 5 Network Communication Configuration

The Eaton Enclosure Power Distribution Unit (ePDU) G3 automatically collects the network communication configuration settings (IP parameters) from the server by default. When the ePDU is not connected to the network, it continuously attempts to connect. If DHCP is enabled on your network, G3 automatically collects the network communication configuration settings.

In order to establish a network session, note the network configuration from the LCD. Users with ePDU User and Admin privileges can review and change the network information using Command Line Interface (CLI), Telnet, and graphical user interface (GUI) once connected.



NOTE In order to use Telnet, you must have a network connection already established.

The ePDU defaults to using Dynamic Host Configuration Protocol (DHCP) when delivered. If you are unable to connect to the ePDU through the network connection with this default address, change the IP address using the LCD or through the CLI using a terminal emulation program.

The network connection automatically receives an IP address through the DHCP if available on the network. If DHCP is enabled but a DHCP server is not available, the eNMC module will use the last-used IP address setting. Alternately, it is possible to set a static IP address by using either the LCD menu or a serial connection command line interface (CLI).

The default settings are:

- DHCP: Enabled
- IP Address: 192.168.123.123
- Subnet Mask: 255.255.255.0
- Gateway: 192.168.123.1
- Username: admin
- Password: admin



NOTE If you use the default IP address and are able to make a direct connection, you could use Telnet to change the settings to some other fixed values.

LCD — DHCP

1. The ePDU defaults to DHCP enabled when delivered.
2. Connect to a network that has a DHCP server and wait 20 seconds before the eNMC module reboots with the new IP address.
3. After 20 seconds, obtain the IP address from the LCD home screen (see Figure 45).



Figure 45. LCD Home Screen

LCD— Static IP address

- 1. Disable DHCP (see Figure 46).

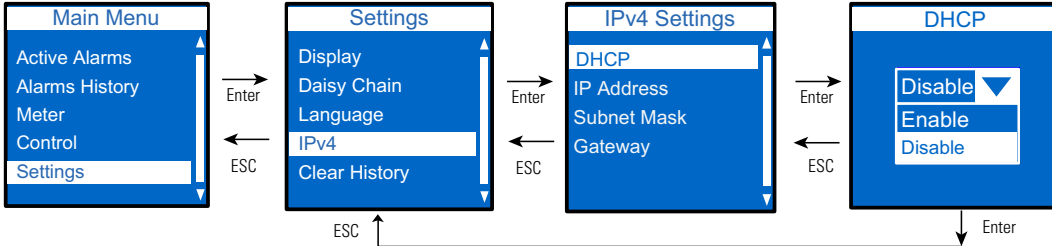

Figure 46. Disable DHCP

- 2. Set the static IP address (see Figure 47). Wait 10 seconds.

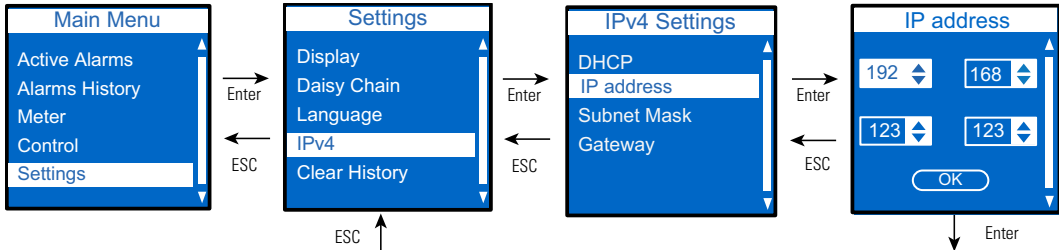

Figure 47. Set the Static IP Address

- 3. After 10 seconds, use the reset button to restart the eNMC module and apply the new settings (see Figure 48).

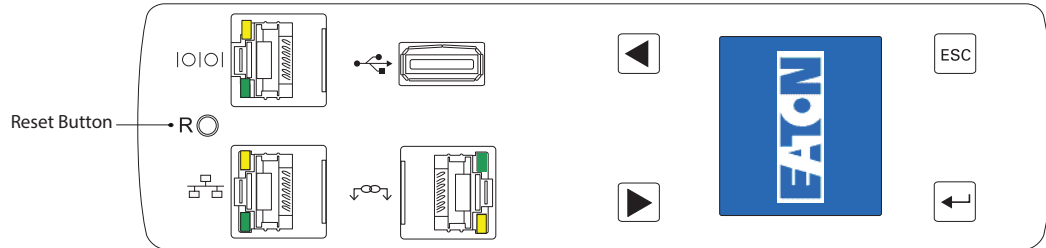

Figure 48. Reset Button (0U Models)

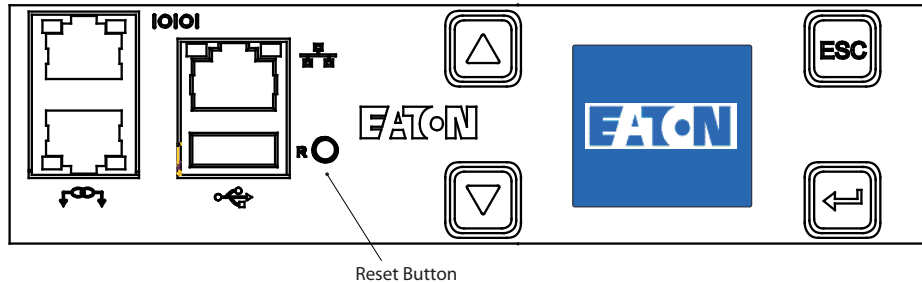

Figure 49. Reset Button (1U and 2U Models)

Serial connection — Static IP address

Use the RJ45-to-DB9 serial cable that is provided to connect the computer to the ePDU. If your computer does not have a DB9 (RS-232) connector, a USB-to-RS-232 adapter can be purchased separately. Access the CLI using a terminal emulation program such as HyperTerminal, PuTTY, or TeraTerm.

To set up the serial port using your selected terminal emulation program, use the following settings:

- Bits per second: 9600
- Data bits: 8
- Parity: None
- Stop bits: 1
- Flow Control: None

After establishing a serial connection, perform the following steps:

1. In the terminal emulator session window, enter the default user name (admin) at the login prompt. For example:

```
Enter Login: admin
```

```
Enter Password:
```

2. Type admin (default) at the password prompt. Press Enter. The CLI uses a "get" command to return the value of a setting and a "set" command to change the value of a setting. For example:

```
PDU#0>set System.Network.DHCP 0
```

```
PDU#0>get System.Network.DHCP
```

```
0
```

3. Type set System.Network.DHCP 0 and press Enter to modify the value (0 = disabled and 1 = enabled). For example:

```
PDU#0>set System.Network.DHCP 0
```

```
0
```

4. Set the IP address to a value provided by your system administrator.

```
PDU#0>set System.Network.IPAddress xxx.xxx.xxx.xxx
```

```
xxx.xxx.xxx.xxx
```

5. If necessary, set the network Subnet Mask to the value required by your system administrator.

```
PDU#0>set System.Network.IPMask 255.255.yyy.yyy
```

```
255.255.yyy.yyy
```

6. Set the network Gateway to the value required by your system administrator.

```
PDU#0>set System.Network.IPGateway zzz.zzz.zzz.zzz
```

```
zzz.zzz.zzz.zzz
```

7. Wait 10 seconds. Use the reset button to restart the eNMC module and apply the new settings.

NOTE 1 You can also connect up to eight ePDUs together using the Daisy-Chain port and an RJ-45 splitter (provided). This enables multiple ePDUs to communicate over one Ethernet port.



NOTE 2 If you choose not to use the procedure to configure the communications module without the DHCP server installed, you can connect to the ePDU using the default address: **<http://192.168.123.123>**

Verify Web Operation After Configuration

To verify the communications module is operational and that you can access the Web interface:

1. Open a Web browser.
2. Enter the IPv4 or IPv6 address in the address bar in the following format:
http://<IPv4 address> or **http://<IPv6 address>**
3. When the user authentication pop-up dialog displays, type **admin** in the User name field and **admin** in the Password field.
4. The home page opens with the ePDUOverview page.

Chapter 6 LCD Interface Operation

This chapter contains operation information for the Eaton ePDUs, including:

- LCD display and control button functions
- Menu selections



NOTE

The LCD language is configurable. See language settings in “Language Submenu” on page 80.

LCD Display and Control Buttons

The ePDU has a four-button, graphical LCD display (see Figure 50). Use the control buttons to change the screen display, retrieve specific performance data, or change configuration values. The display view can also change automatically. For example, the display changes to show active alarms as they occur, or particular displays update due to a change in operating state.

A backlight is used to light up the display with white and blue:

- The backlight turns off automatically when no button has been pressed for 15 minutes and there is no active alarm.
- Any active alarm will cause the backlight to turn on automatically.





A red blinking background indicates that an alarm is active.



Figure 50. LCD Display

Table 5 summarizes how to use the control buttons.

Table 5. Control Buttons

Button	When on the Main Menu	When in Screensaver mode	When in Menu mode
	Returns to the Start-up screen.	Returns to the previous display screen before entering the screensaver mode.	Returns to the previous display screen.
	Opens the selected menu. NOTE: When menu items are highlighted, they are selected.	Returns to the previous display screen before entering the screensaver mode.	Signals that you want to set the values as displayed on the screen. NOTE: On information screens, this button has no action.
 	Scrolls up or down through the list of menu items.	Returns to the previous display screen before entering the screensaver mode.	Scrolls up or down to the next screen or value.

Operation Mode

Screensaver Cycling Sequence

The screensaver displays automatically after 30 seconds of inactivity from the start-up screen, a menu, or a submenu. Values are reset every five seconds. The screensaver displays data in a preset 1Ph cycle (Figure 51) or 3Ph cycle (Figure 52). These cycles are not user-configurable.

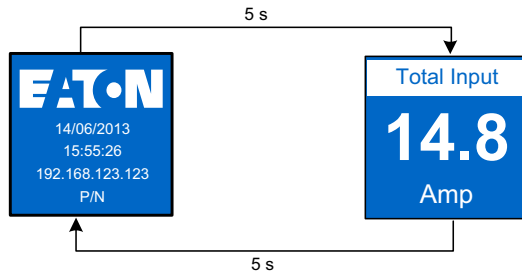

Figure 51. 1Ph Screensaver Cycle

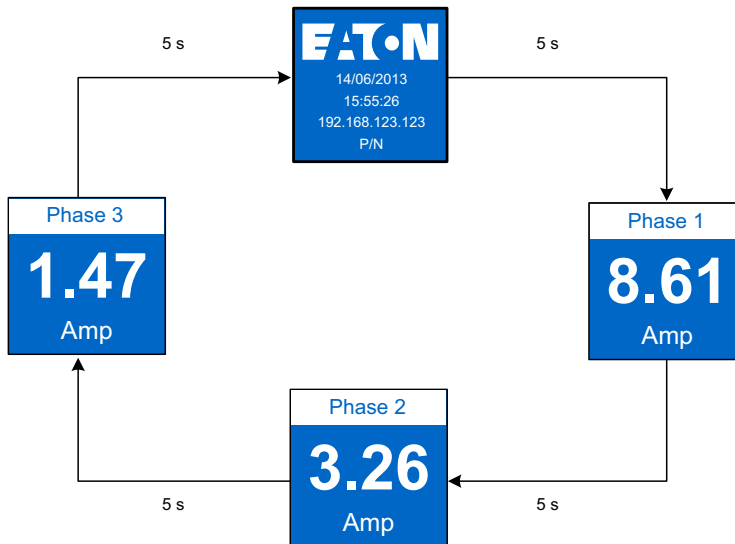

Figure 52. 3Ph Delta-configured Screensaver Cycle

Startup Screen

When the ePDU powers up, the Startup screen displays (see Figure 53). Press **ENTER** to go to the Main Menu.



Figure 53. Startup Screen

Password Protected Menus

Both Control and the Settings menus can be password-protected. This locks out the menus to any user who does not know the password.

Password configuration can only be done through the Web interface and the CLI menu.

Figure 54 illustrates the sequence to enter a password for a locked menu.

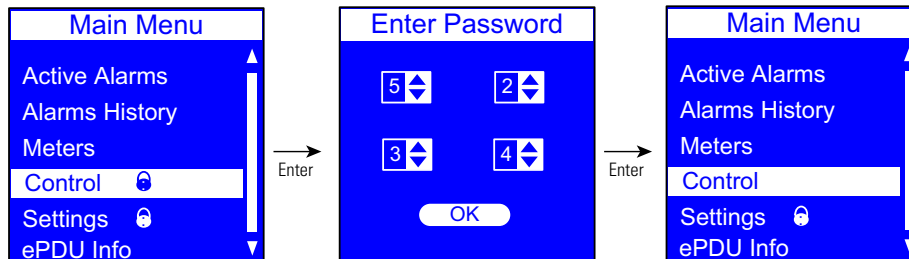

Figure 54. Password Protected Screens

Main Menu Selections

The ePDU menu selection hierarchy provides useful performance information, alarms, ePDU identification, and configuration settings (see Figure 55). The available menu items are illustrated in a menu hierarchy in Figure 56.

- Use the scroll buttons to select a menu item from the Main Menu.
- Selected menu items are highlighted and display as blue text on a white bar.
- Press **ENTER** to go the selected menu item.
- Press **ESC** from the Main Menu to return to the Startup Screen.



NOTE The Control Menu is not available for Metered Input (MI) and Metered Outlet (MO) ePDUs.

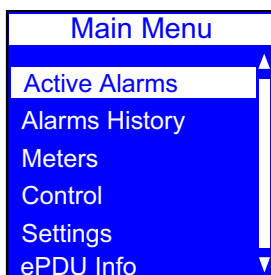
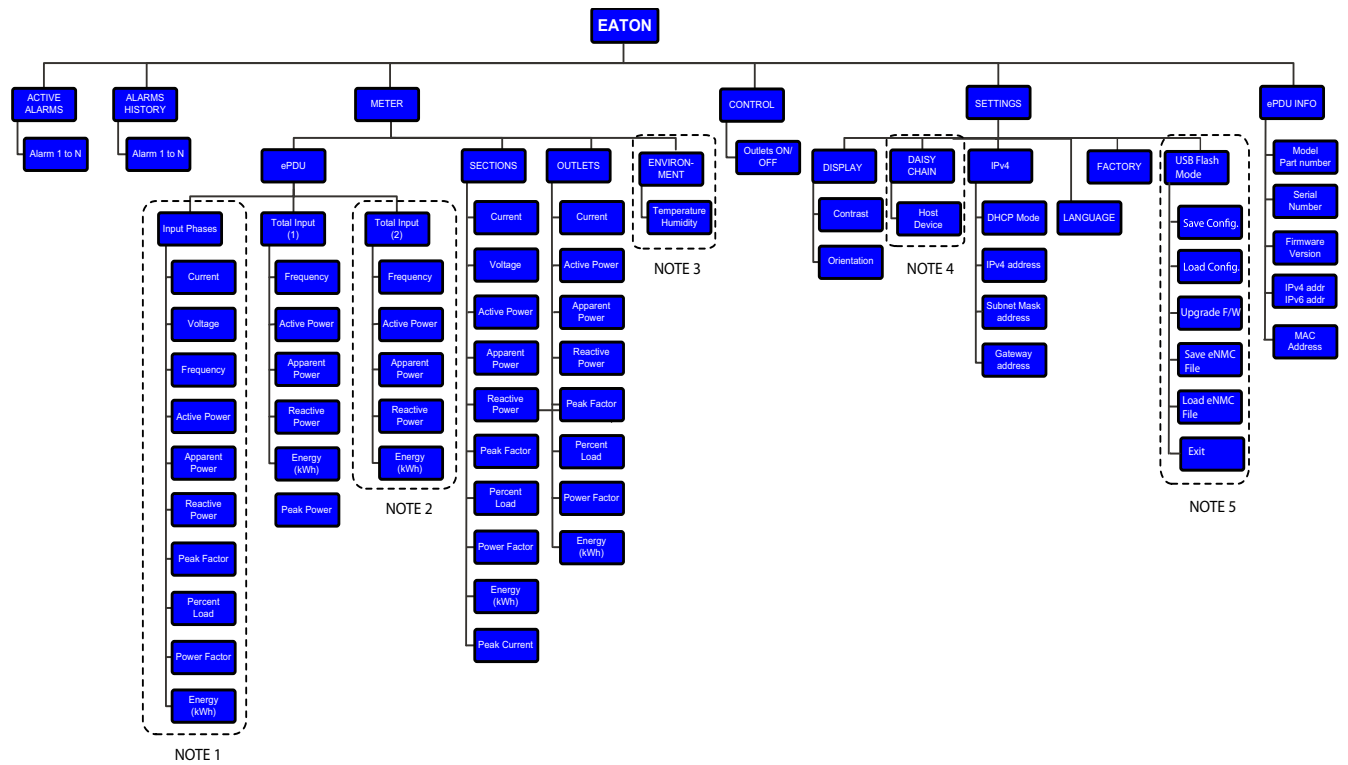

Figure 55. Main Menu Selections



NOTE 1 These submenus are only available for 3Ph input ePDUs.

NOTE 2 These submenus are only available for dual input ePDUs.



NOTE 3 This menu and submenu are only available if an EMP is connected.

NOTE 4 This submenu is only available for Host ePDUs when a daisy-chained configuration is used.

NOTE 5 This submenu is only available if a USB drive is detected.

Figure 56. ePDU Menu Hierarchy

Different sets of menus display depending on the type of topology you are managing or monitoring.

Table 6 shows LCD menus that are valid for ePDU topologies.

Table 6. Menus Available for ePDU Topologies

Models	Active Alarms	Alarm History	Meter ^{see NOTE 1}						Settings	ePDU Info
			ePDU			Sections	Outlets	Control		
			Input Phase	Total Input (1)	Total Input (2) <small>NOTE3</small>					
Basic (BA)	—	—	—	—	—	—	—	—	—	—
Metered Input (MI)	•	•	NOTE2	•	—	•	—	—	•	•
Metered Outlet (MO)	•	•	NOTE2	•	—	•	•	—	•	•
Switched (SW)	•	•	NOTE2	•	—	•	—	•	•	•
Managed (MA)	•	•	NOTE2	•	—	•	•	•	•	•

NOTE 1 The **Meter > Environment** menu is only available if an Environmental Monitoring Probe (EMP) is attached.

NOTE 2 The Input Phase menu is available if the ePDU has multiple phases.

NOTE 3 The Total Input (2) menu is available if the ePDU has multiple inputs

Active Alarms Menu

The Active Alarms menu filters and displays only active alarms for the ePDU. Active alarm screens have priority over other screens. When an alarm occurs, the Active Alarms screen replaces the current screen and the backlight blinks in red and white (see Figure 57). Up to 100 active alarms can display.

On the Main Menu, scroll up or down to highlight **Active Alarms**. Press **ENTER** to display the first active alarm screen. Scroll up or down if needed to view active alarm data. When you finish your review, press **ESC** to return to the previous menu. If the backlight was blinking red to indicate an active alarm, the backlight returns to normal.

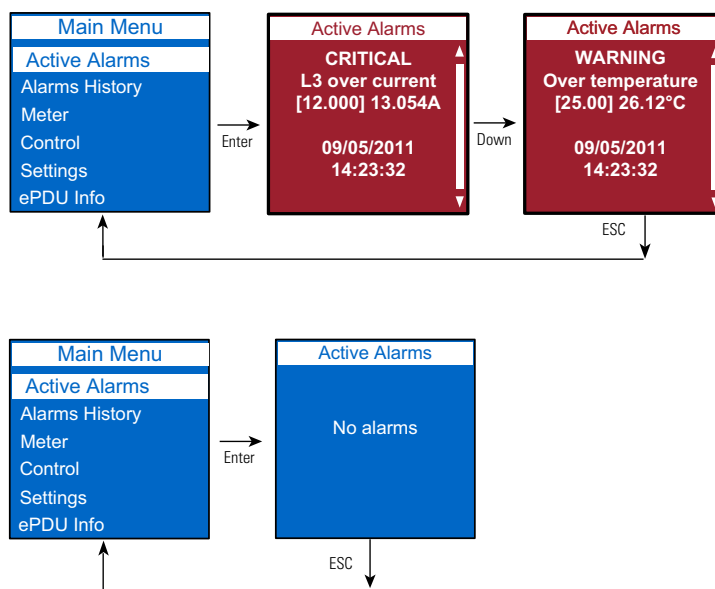

Figure 57. Example Active Alarm Displays

Alarms History Menu

The Alarms History menu allows you to scroll through the last 50 logged alarms, beginning with the most recent alarm. The Alarms History screens contain the type of alarm, the date (*MM/DD/YYYY*), and time (*hh:mm:ss*) when the alarm occurred (see Figure 58).

On the Main Menu, scroll up or down to highlight **Alarms History**. Press **ENTER** to display the most recent alarm in the history log. Scroll up or down to view the alarms. When you finish your review, press **ESC** to return to the previous menu.

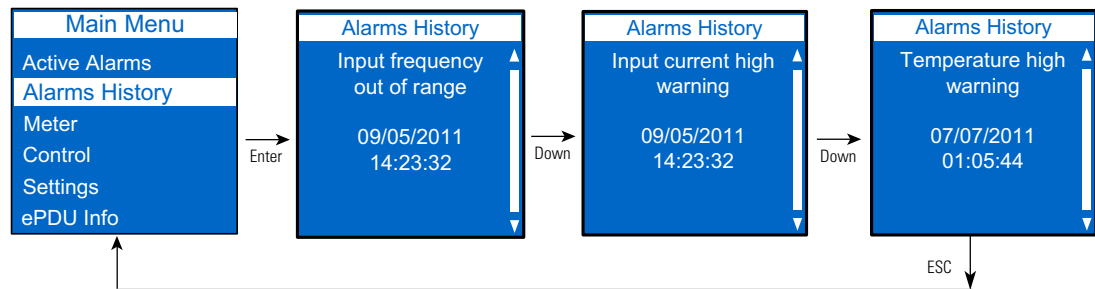

Figure 58. Example Alarm History Displays

Meter Menu

The Meter menu provides measurement data for the following submenus:

- ePDU
- Sections (not available for sections that do not have current measurement)
- Outlets (not available for MI and SW ePDUs)
- Environment (only available if an EMP is installed)

On the Main Menu, scroll up or down to highlight **Meter**. Press **ENTER**. Scroll up or down to select a submenu and press **ENTER** to display the submenu options. Press **ESC** to return to the previous menu.

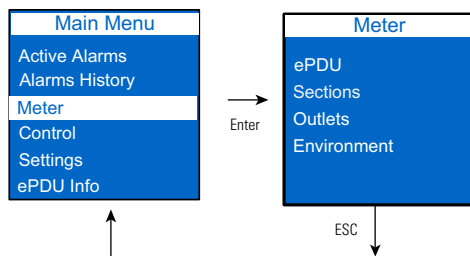

Figure 59. Example Meter Menu Display



NOTE The measurement data for each screen is refreshed every two seconds.

ePDU Submenu

These screens display Total Input data measurements for ePDUs. In addition to Total Input measurements, you can view Phase Input data measurements for 3Ph, split-phase, and dual input ePDUs. Depending on the ePDU electrical topology, different ePDU measures will display in the Total Input and the Input Phase meter screens.

Table 7 shows which measures will be present:

Table 7. Measures for Total Input and Phase Input Meter Screens

Measure	Total Input	Wye-wired Input Phase	Delta-wired Input Phase
Frequency	•	—	—
Voltage	—	•	•
Current	—	•	•
Percent Load	—	•	•
Active Power	•	•	—
Crest Factor	—	•	•
Apparent Power	•	—	—
Reactive Power	•	—	—
Power Factor	•	—	—
Energy	•	—	—
Peak Power	•	—	—

Total Input Meter Data

On the Meter menu, scroll up or down to highlight ePDU. Press **ENTER** to display the Total Input submenu for your 1Ph, 3Ph, split-phase, or dual input ePDU. Press **ENTER** again to see Total Input meter data measurements. Scroll up or down to review other Total Input meter data measurements. After you review the data, you can press **ESC** to return to the Input Meter menu and select L1, L2, or L3 to see Phase Input measurements. Press **ESC** to return to the previous menu.

For example, Figure 60 shows a total input display for 1Ph ePDUs.

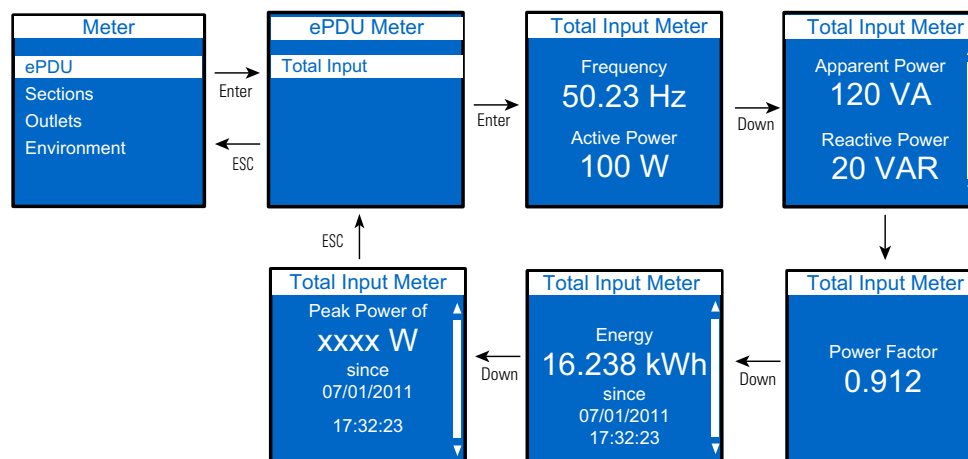

Figure 60. Example 1Ph Total Input Display



NOTE

The **Total Input > Input Meter** selection screens will be different for 1Ph, 3Ph, dual input, and split-phase ePDUs.

Figure 61 shows an input phase display for wye-wired 3Ph ePDUs.

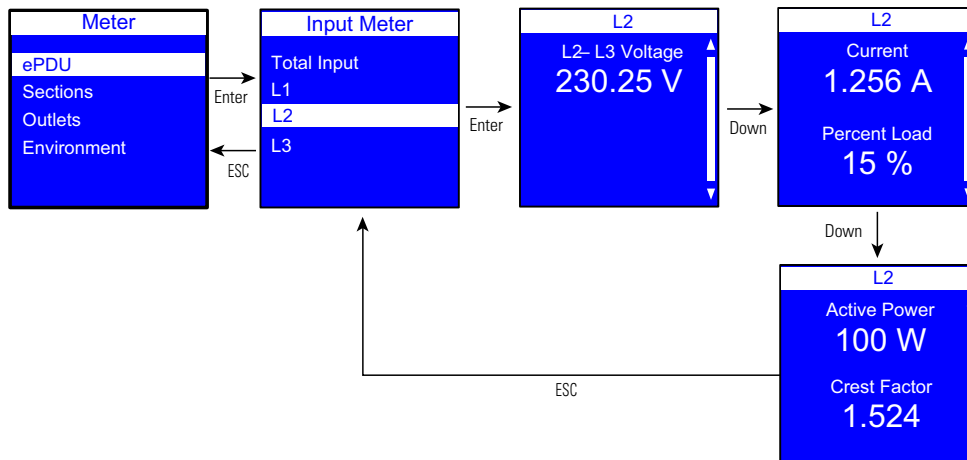

Figure 61. Example 3Ph Input Phase (wye-wired) Display

Sections Submenu

Section measurements include voltage data for all ePDU sections. Other sections measurements are only available on ePDUs that have current measurement capabilities (see Figure 62).

On the Meter menu, scroll up or down to highlight **Sections**. Press **ENTER** to display the Sections submenu. Scroll up or down to review the data for your selection. After you review the data, press **ESC** twice to return to the previous menu.

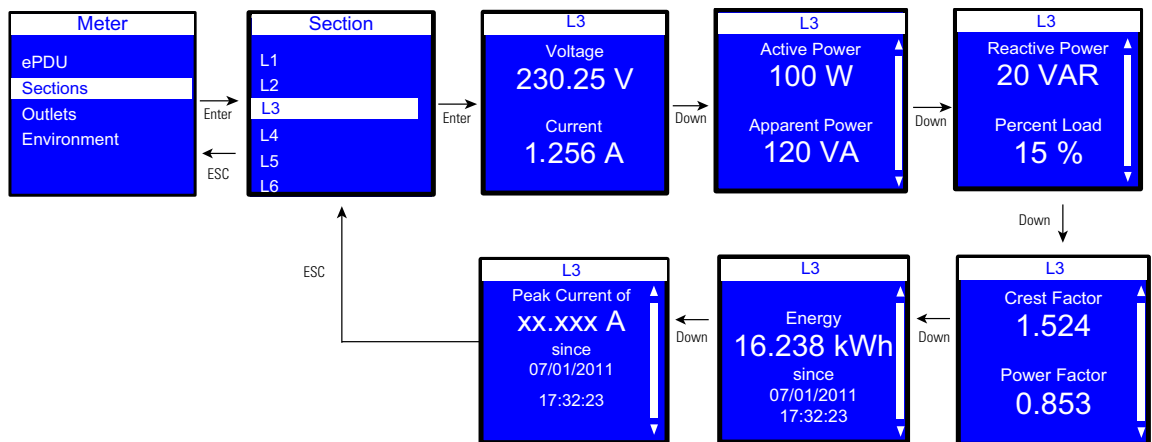

Figure 62. Example Section Submenu Display

Outlets Submenu

On the Meter menu, scroll up or down to highlight **Outlets**. Press **ENTER** to display the Outlets submenu. Scroll up or down to review the data for your selection. After you review the data, press **ESC** twice to return to the previous menu (see Figure 63).

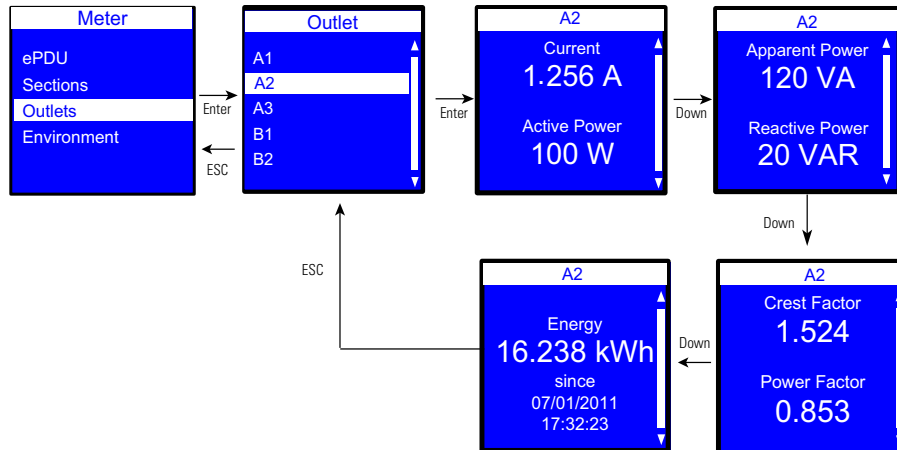

Figure 63. Example Outlets Submenu Display

Environment Submenu

The Environment submenu provides temperature and humidity data for the EMP. This menu is only available if an EMP is installed.

On the Meter menu, scroll up or down to highlight **Environment**. Press **ENTER** to display the Environment submenu. Press **ENTER** to review the data for your selection. After you review the data, press **ESC** to return to the previous menu. (Contact closures are not displayed on the LCD.)

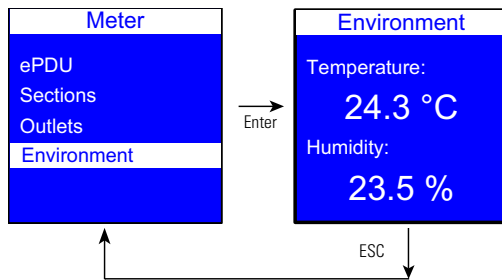

Figure 64. Example Environment Submenu Display

Control Menu

For Switched (SW) and Managed (MA) ePDUs only. On the Main Menu, scroll up or down to highlight **Control**. Press **ENTER**. Scroll up or down to see a list of outlet group IDs. Select an outlet group. The On/Off drop down list displays. Select On or Off. The selected state of the outlet displays. Scroll up or down to see other lists of outlet group IDs (if available). Press **ESC** to return to the previous menu (see Figure 65).

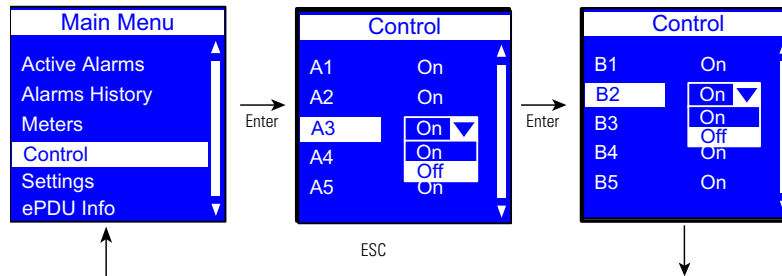

Figure 65. Example Control Submenu Display

Settings Menu

The Settings menu provides user configuration options. Only the available options display, depending on the assigned user privileges.

There are five standard Settings submenus and one optional submenu:

- USB Flash mode (only available if the USB device is detected)
- Display
- Daisy Chain
- Language
- IPv4
- Factory

On the Main Menu, scroll up or down to highlight **Settings**. Press **ENTER**. Scroll up or down to select a submenu and press **ENTER** to display the submenu options. Press **ESC** to return to the previous menu.

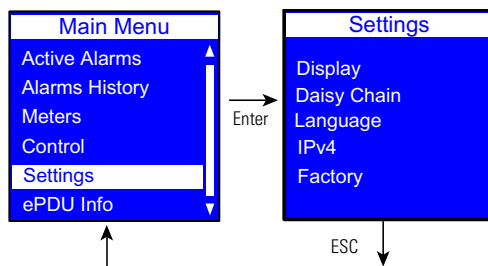

Figure 66. Example Settings Menu Display

USB Flash Mode Submenu

The “USB Flash Mode Submenu” displays in the Settings menu when a USB device is detected in the USB port. The menu selection does not display when the USB device is removed.

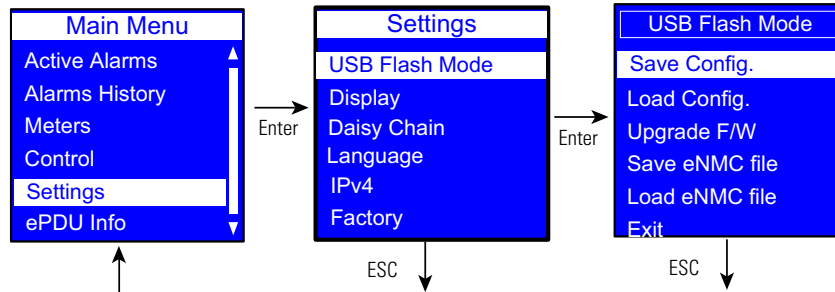

Figure 67. Example Settings USB Flash Mode Menu Display

Save User-Customized Settings Configuration Files to the USB

This LCD menu option allows you to save the user-customized configuration settings files to the USB drive. These files contain your custom settings, such as network parameters, outlet names, and threshold values. If you have several ePDUs of the same model and hardware configuration, you can copy the customized setting files from one ePDU and upload the files to the rest of the ePDUs. This will help ensure consistency of the settings and save set-up time.

After this procedure is completed, the following files will exist on the USB device:

- eNMC/config/ConfigurationData.xml - Contains all network and communication-related settings. This can be saved from and loaded to any ePDU G3 when replicating configurations regardless of part number.
- eNMC/config/ConfigurationPdu.xml - Contains all the user-configurable settings related to the ePDU itself such as voltage and current thresholds, customized naming, and outlet control parameters. The structure of this file depends on the part number so that it cannot be duplicated from part number x to part number y (PNx to PNy).

To save the user data configuration settings files to the USB drive:

1. Make sure eNMC module is power ON.
2. Insert a USB device in the USB port. Verify the USB drive contains the eNMC/config directory located at root of USB drive.
3. When the pop-up confirms that the USB is detected, click **OK**, and then press **Enter** to return to the Main Menu. (If not confirmed within 10 seconds, the pop-up goes away by itself.)
4. Under Settings, select USB Flash Mode.
5. The eNMC module restarts. (If there is no action within one minute, the eNMC module exits the USB Flash mode. Remove and reinsert the USB drive to access this menu again.)
6. Select Save Config (see Figure 68).

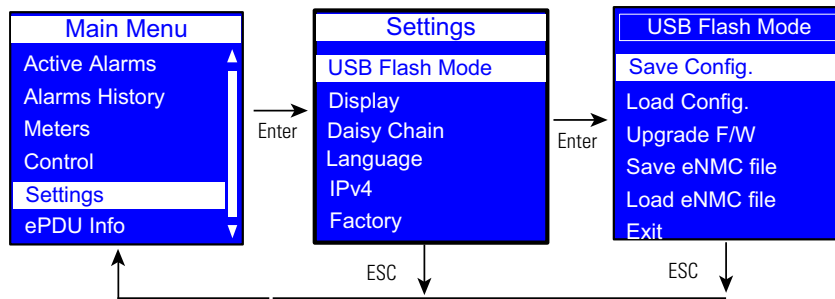

Figure 68. Example Save Config.

7. Click **OK** to continue when a successful pop-up message displays the following see Figure 69):
 - The ConfigurationData.xml file is saved in the eNMC/ config directory on the USB drive.
 - The ConfigurationPdu.xml file is saved in the eNMC/ config directory on the USB drive.

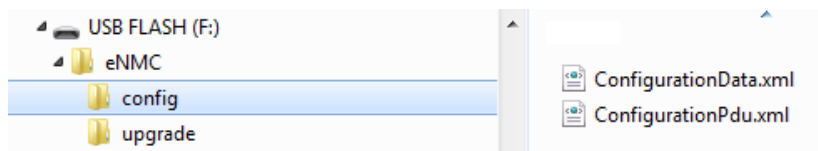

Figure 69. Example USB Root with eNMC Config Directory

8. Remove the USB drive and select **Exit**.

Load User-Customized Settings Configuration Files from the USB

This option loads the ConfigurationData.xml and ConfigurationPdu.xml files into the eNMC module from the USB device. The new parameters in these files will be applied when the eNMC module exits USB Flash Mode.

When this option is selected, the eNMC module will first attempt to load the eNMC/config/ ConfigurationData.xml file from the USB device. Next, the eNMC module will attempt to load the eNMC/config/ ConfigurationPdu.xml file from the USB device.

The ConfigurationPrivateData.xml file contains private data that is not recommended to be copied:

- Select the DHCP/static IP parameter
- Hostname parameter
- IP address parameter
- IPv6 address parameter
- Daisy Chain parameters

1. Verify that the USB drive contains the ConfigurationPdu.xml file and ConfigurationData.xml files in eNMC/config directory of USB drive (see Figure 70).

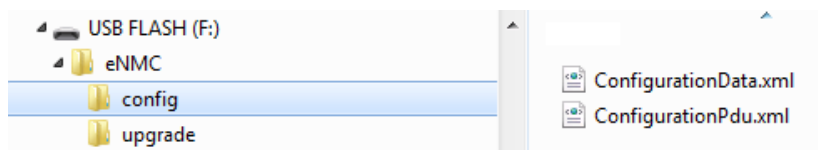

Figure 70. Verify Files at USB Root



NOTE 1 The eNMC/config directory contains only these two files.

NOTE 2 The ConfigurationPdu.xml file is compatible with a specific ePDU part number.

2. Make sure eNMC module is powered ON.
3. Insert a USB drive.
4. When the pop-up confirms that the USB is detected, click **OK** then press **Enter** to go to the Main Menu. (If not confirmed within 10 seconds, the pop-up goes away by itself.)
5. Select USB Flash Mode from the Settings menu. The module restarts.
6. Select Load Config then click **OK** to start loading the ConfigurationData.xml file into the eNMC module (see Figure 71).

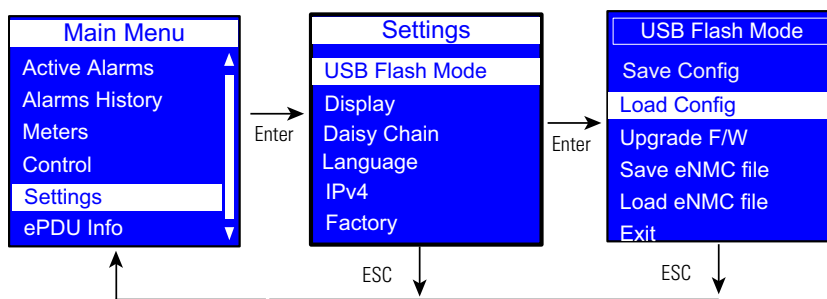

Figure 71. Example Load Config.

7. When the file is successfully loaded, click **OK** in response to the confirmation message.
8. Click **OK** to start loading the ConfigurationPdu.xml file into the eNMC module.
9. When the file is successfully loaded, click **OK** in response to the confirmation message.
10. Remove the USB drive and select **Exit** from the USB Flash Mode menu.

Save the ePDU Hardware Configuration File to the USB

See “Replacing the ePDU Network Management and Control Module” on page 135 to understand this selection in proper context. This procedure is used as part of the eNMC module replacement procedure. Each ePDU model has a model-specific hardware configuration file for its eNMC module that can only be used on the specified model. This procedure allows you to copy the ePDU hardware configuration file from a working ePDU of the same model and store it on a USB flash drive so that it can be uploaded to a new eNMC module.

To save the ePDU model-specific hardware configuration file to a USB drive:

1. Make sure the eNMC module is powered ON. Connect a USB flash drive to a working ePDU.



IMPORTANT

This ePDU must be of the same model type and configuration as the ePDU that houses the eNMC you will replace.

2. When the LCD interface pop-up confirms that the USB flash drive is detected, click **OK**, and press **Enter** to return to the Main Menu. (If not confirmed within 10 seconds, the pop-up goes away by itself.)
3. From the LCD Settings menu, select USB Flash Mode. Press **Enter**, select **yes** to confirm, and then press **Enter** again. The module restarts. (If there is no action within one minute, the eNMC module exits USB Flash Mode. Remove and reinsert the flash drive to access this menu again.)

4. Select Save eNMC file to save the ePDU hardware configuration file to the USB drive (see Figure 72). The file will save to the eNMC/config/hw path at the USB drive root directory (see Figure 73).

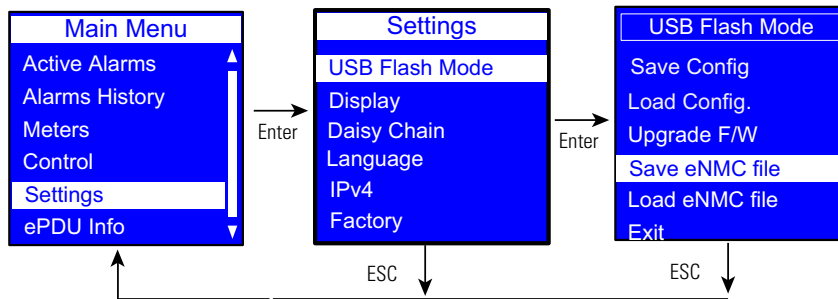

Figure 72. Example Save eNMC File

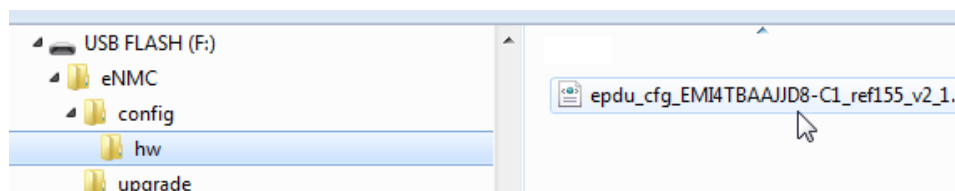

Figure 73. Verify HW File at USB Root

5. When the file is saved, click OK to confirm.

Load the ePDU Hardware Configuration File from the USB to the eNMC Module

See “Replacing the ePDU Network Management and Control Module” on page 135 to understand this selection in proper context. This procedure is used as part of the replacement procedure.

The ePDU hardware configuration file provides the replacement eNMC module with the characteristics of the ePDU model in which it resides, such as the type of input, the number of circuit breakers and outlets, and the way measurements should be displayed. Use this menu selection to upload the ePDU model-specific hardware configuration file to the replacement eNMC module.



NOTE

This selection will only display in the menu if an ePDU hardware configuration file is detected on the USB drive.

To load the ePDU model-specific hardware configuration file to an eNMC module:

1. Make sure the eNMC module is powered ON. Connect the USB flash drive to the ePDU with the new eNMC module.
2. When the LCD interface pop-up confirms that the USB flash drive is detected, click **OK**, then press **Enter** to return to the Main Menu. (If not confirmed within 10 seconds, the pop-up goes away by itself.)
3. From the LCD Settings menu, select USB Flash Mode. Press Enter, select yes to confirm, and then press Enter again. The module restarts. (If there is no action within one minute, the eNMC module exits USB Flash Mode. Remove and reinsert the USB flash drive to access this menu again.)
4. Select Load eNMC file, then click **OK** to upload the ePDU hardware configuration file to the eNMC (see Figure 74).
5. When the file is successfully loaded, click **OK** to confirm.
6. Remove the USB flash drive and select **Exit**.

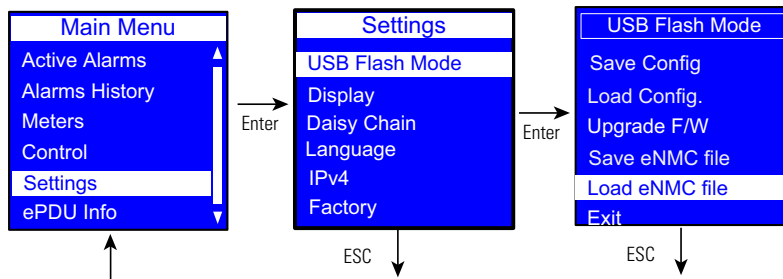

Figure 74. Example Load NMC File

- NOTE 1** The eNMC/upgrade/hw directory contains only one file named epdu_cfg*.xml.
- NOTE 2** The epdu_cfg*.xml file shall be compatible with the ePDU part number.

Upgrade the eNMC Module Firmware using USB

To upgrade the eNMC module firmware:

1. Go to www.eaton.com/ePDU.
2. Enter the ePDU part number of your model in the ePDU Part Number Search field and click **Search**. The product Web page displays.
 1. Select the **Options** tab and click either the ePDU Firmware link or the free download link. The Download - ePDU Software Tools and MIBs page displays.
 2. Click the link to the firmware upgrade file for your model in the column named ePDU Firmware (Advanced Monitored, Switched, and Managed ePDUs) and save the file to your computer.

- NOTE** The file is named Image*.bin.

3. Connect a USB drive to your computer and put the Image*.bin file in the eNMC/upgrade/ location on the USB drive root directory (see Figure 75).

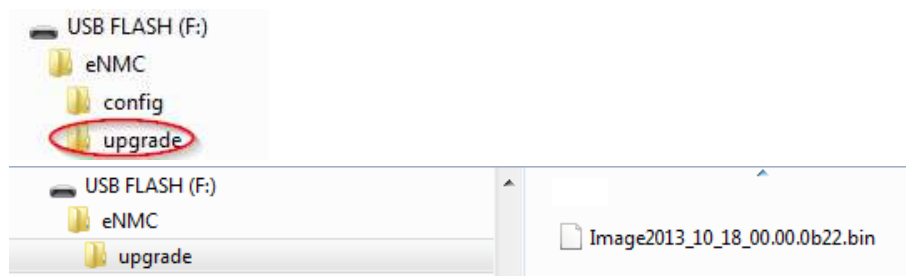

Figure 75. Root Directory of Flash Disk

- NOTE** There can only be one Image*.bin file in the eNMC/upgrade directory on your USB drive.

4. Make sure eNMC module is powered ON.
5. Insert the flash drive in the USB port of the eNMC front panel.

- When the pop-up confirms that the USB is detected, click **OK**, and then press **Enter** to return to the Main Menu. (If not confirmed within 10 seconds, the pop-up goes away by itself.)
- Select USB Flash Mode. Click **Yes** to confirm you want to enter the USB Flash mode. (If there is no action within one minute, the eNMC module exits the USB Flash mode. Remove and reinsert the USB drive to access this menu again.) The module restarts.
- Select Upgrade FW and click **OK** to confirm the upgrade (see Figure 76). The eNMC module gets the file from the USB drive.

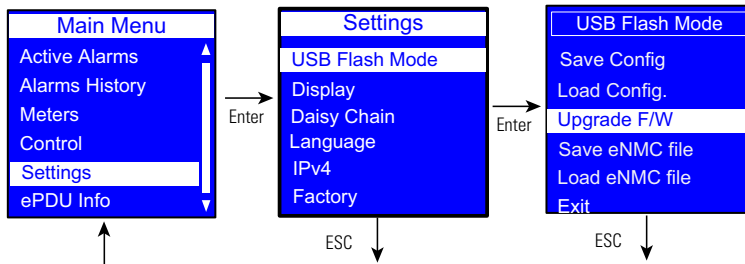

Figure 76. Example Select Upgrade Firmware

- A few seconds after 100% is reached, the eNMC module restarts and then enters in Boot upgrade mode to continue upgrade. The upgrade is finished when eNMC module is restarted. This can take several minutes (see Figure 77).

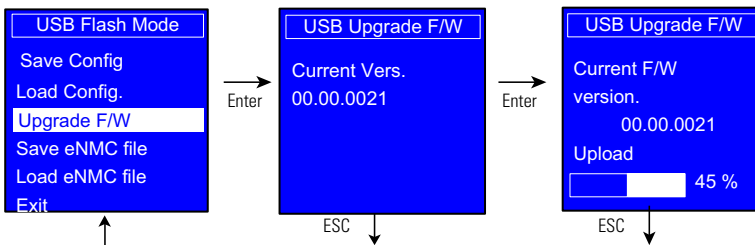

Figure 77. Example Upgrade in Progress

Exit

Select **Exit** to leave USB Flash Mode.

Display Submenu

The Display submenu allows you to customize settings for LCD contrast and orientation (see Figure 78).

On the Settings menu, scroll up or down to highlight **DISPLAY**. Press **ENTER** to display the screens to set the values for the submenu. After you select the values, press **ENTER** to set the values as displayed on the screen. Press **ESC** to return to the previous menu.

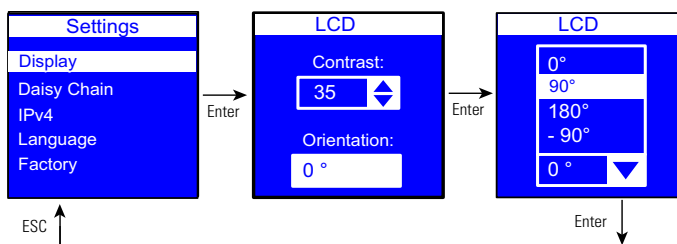

Figure 78. Example Display Submenu Displays

Daisy Chain Submenu

The Daisy Chain submenu allows you to configure two to eight ePDUs to be monitored from a single Ethernet connection on the Host ePDU. Use the Daisy Chain submenu options (Settings and Discovery) to configure the ePDUs.

NOTE 1 The Host ePDU must be connected to the network. There can only be one Host.

NOTE 2 To configure and monitor the ePDUs, they must be connected together through the Daisy Chain connector on the front panel using an Ethernet network cable.



NOTE 3 All daisy-chained ePDUs should have the same Configuration number. Daisy-chaining G3 ePDUs of different configuration numbers may lead to unpredictable results.

Use the Settings option for the first two configuration steps:

1. From the ePDU (or ePDUs) designated as a Device ePDU, access the Daisy Chain Settings option and set the Device values.
2. From the ePDU designated as the Host ePDU, access the Daisy Chain Settings option and set the Host values.

Use the Discovery option for the final configuration step:

3. From the Host ePDU, access the Daisy Chain Discovery option to start communication between the Host and the Device ePDU (or ePDUs).

Daisy Chain Settings Options

The Daisy Chain Settings option allows you to specify the ePDU that will be the Host (the ePDU that has the network connection) and the ePDU (or ePDUs) that will be a Device.

From the LCD of the **Device** ePDU (or ePDUs), set the values as follows (see Figure 79):

1. On the Settings menu, scroll up or down to highlight **Daisy Chain** and press **ENTER**.
2. Scroll up or down to highlight **Daisy Chain** and press **ENTER**.
3. Select **1 (Device), 2 (Device), 3 (Device), 4 (Device), 5 (Device), 6 (Device), or 7 (Device)** from the Id: selection drop-list. Press **ENTER**.
4. Select **End** or **Middle** from the Place: selection drop-list. Press **ENTER**.

NOTE 1 Select **End** when only two ePDUs are daisy-chained together.



NOTE 2 Select **Middle** when the ePDU (or ePDUs) are connected between a host and another ePDU.

NOTE 3 Select **End** when assigning the last device in the chain when daisy-chaining three or more ePDUs.

5. Press **ESC** to return to the previous menu.

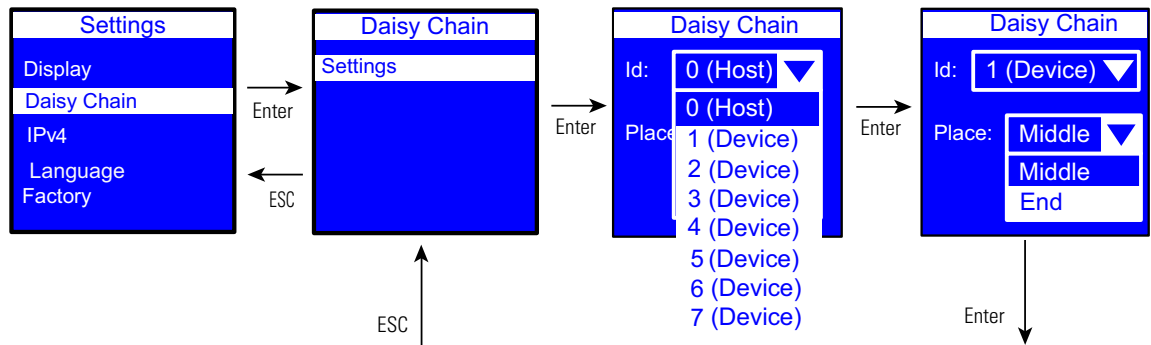

Figure 79. Example Daisy Chain Device ePDU Setup (Device)

From the LCD of the **Host** ePDU, set the values as follows (see Figure 80):

1. On the Settings menu, scroll up or down to highlight **Daisy Chain** and press **ENTER**.
2. Scroll up or down to highlight **Settings** and press **ENTER**.
3. Select **0 (Host)** from the Id: selection drop-list. Press **ENTER**.
4. Select **End** or **Middle** from the Place: selection drop-list. Press **ENTER**.
5. Press **ESC** to return to the previous menu.

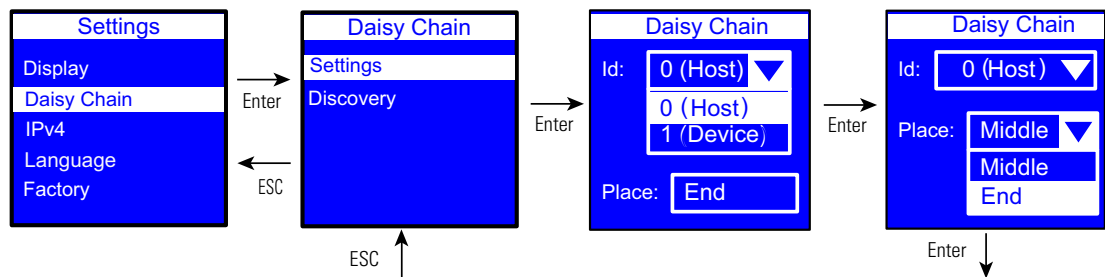

Figure 80. Example Daisy Chain Host ePDU Setup (Host)

Daisy Chain Discovery Options

The Discovery option starts communication between the Host ePDU and the Device ePDU. This is only available for the Host ePDU. The display you see varies depending on whether the ePDU is communicating properly or not communicating (see Figure 81 and Figure 82).

From the Host ePDU, perform a Discovery as follows:

1. On the Settings menu, scroll up or down to highlight **Daisy Chain** and press **ENTER**.
2. Scroll up or down to highlight **Discovery**.
3. Press **ENTER** to perform the discovery.
 - When the discovery completes successfully, the Media Access Control (MAC) address of the Device ePDU displays (see Figure 46). Go to Step 4.
 - If there is no connection, the **No device chained** error message displays (see Figure 47). Go to the Daisy Chain Settings option screens and reset the values to correctly identify the Host. Once corrected, then select the Discovery option again.
 - If the Host and Device ePDUs have been incorrectly identified, a **Host Conflict** error message displays. Go to the Daisy Chain Settings option screens and reset the values to correctly identify the Host and Device. Once corrected, select the Discovery option again.
4. Press **ENTER** to validate the Discovery.
5. Press **ESC** to return to the previous menu.

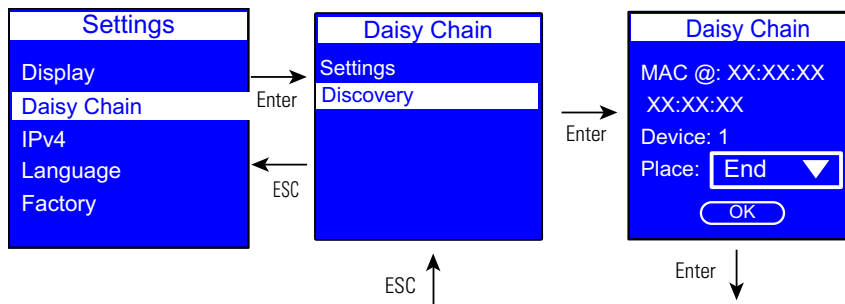

Figure 81. Example Daisy Chain ePDU Discovery (Communicating)

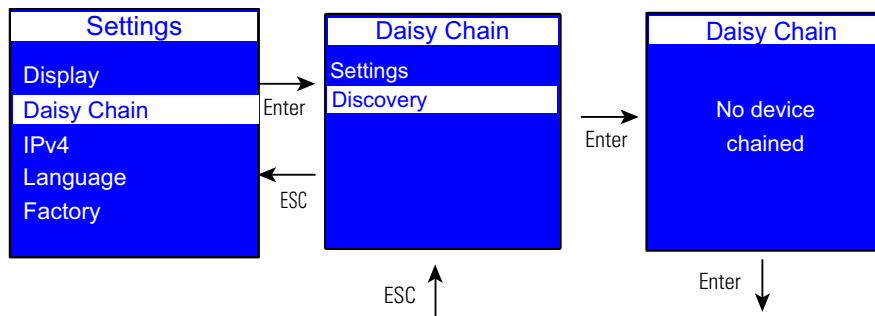

Figure 82. Example Daisy Chain ePDU Discovery (Not Communicating)

IPv4 Submenu

The IPv4 submenu allows you to set options for:

- DHCP
- IP address
- Subnet Mask
- Gateway

Figure 83 shows the IP Address displays.

On the Settings menu, scroll up or down to highlight IPv4. Press **ENTER** to display the options screen. Scroll up or down to highlight the selected option from the menu. Press **ENTER** to display the screens to set the values for the selected option. After you select the values, press **ENTER** to set the values as displayed on the screen. Press **ESC** to return to the previous menu.

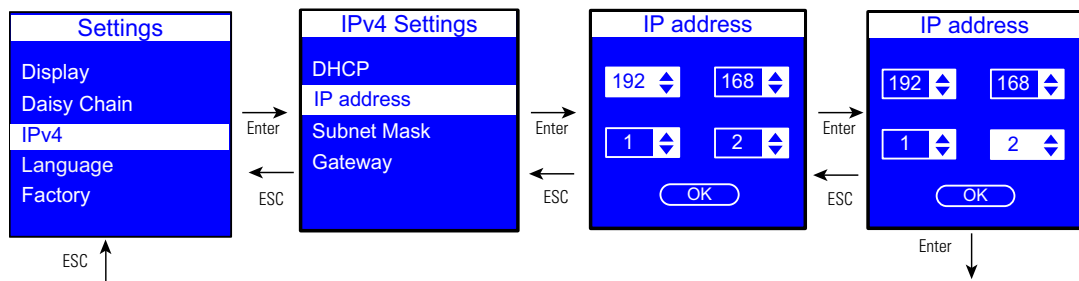

Figure 83. Example IPv4 Submenu Displays

Language Submenu

On the Settings menu, scroll up or down to highlight Language. Press **ENTER**. Scroll up or down to highlight the selected language option from the menu. Press **ENTER** to set the selected language. Press **ESC** to return to the previous menu (see Figure 84).

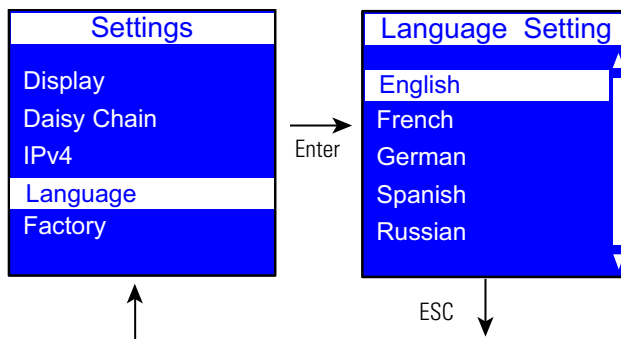

Figure 84. Example Language Setting

Factory Submenu

The Factory submenu allows you to reset the ePDU to the factory settings (see Figure 85).

On the Settings menu, scroll down to highlight Factory. Press **ENTER** to display the screens to set and confirm the return to factory settings. After you make the selections, press **ENTER** to set the values as displayed on the screen. Press **ESC** to return to the previous menu.

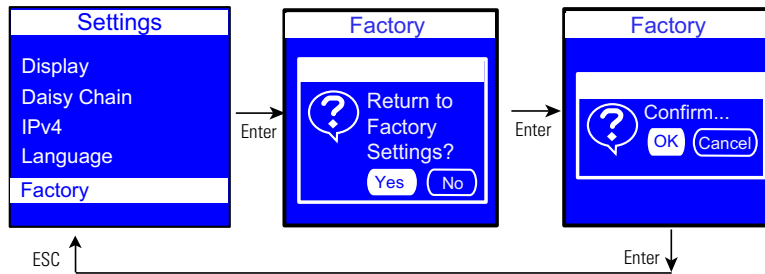

Figure 85. Example Factory Submenu Displays

ePDU Info Menu

The ePDU Info menu provides identification information for this ePDU. The identification information includes the ePDU model type and part number, serial number, ePDU Network Management and Control (eNMC) module firmware version number, IP address, and ePDU Network Management and Control (eNMC) module MAC (Media Access Control) address. These are information-only screens (see Figure 86).

On the Main Menu, scroll up or down to highlight ePDU Info. Press **ENTER** to navigate to each screen. Scroll up or down on the screen if needed to view the ePDU information displays. Press **ESC** to return to the previous menu.

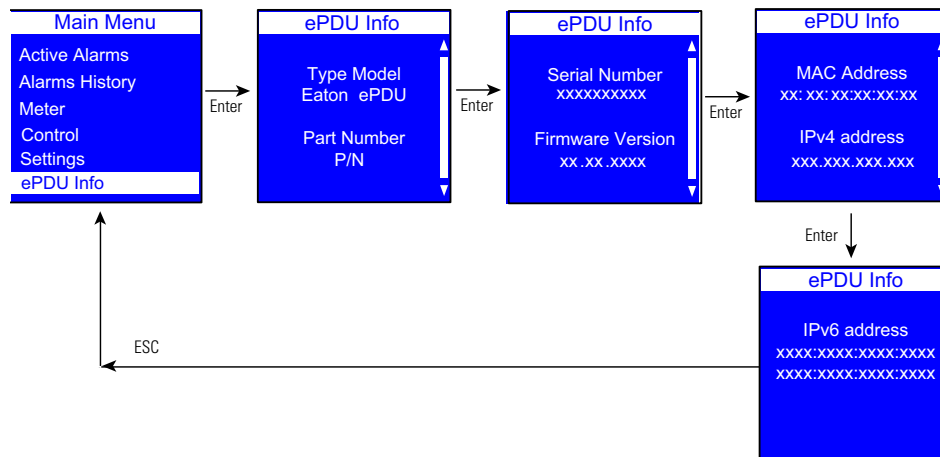

Figure 86. Example ePDU Info Display

Chapter 7 Serial Interface Operation

This section describes the command line interface (CLI) commands used to remotely configure and monitor the Eaton Enclosure Power Distribution Unit (ePDU) G3 through the serial interface connection or network connection between the and a laptop or workstation.

Access to a CLI is provided through a terminal emulation program, such as HyperTerminal, Telnet, or SSH. A maximum of five concurrent sessions (Telnet or RS-232 port) are allowed.

Supported Commands

The ePDU CLI command set for managing and monitoring the ePDU includes the following commands:

- ?
- info
- quit
- get
- set
- pdu

NOTE Observe the following:



- Command variables are represented in command input syntax surrounded by angle braces (< >).
- Optional parameters are represented in command input syntax surrounded by straight brackets ([]).
- For data of type array, the 'x' character as index of array in command input syntax means all indexes.
- Commands are case sensitive, but object names are not case sensitive.



NOTE You must be logged into the ePDU before commands can be sent.

? command

Use this command to list all available ePDU CLI commands or receive detailed help on specified commands.

Usage

```
pdu#0>?
pdu#0><command> ?
```

where:

<command> = info, get, set, pdu, quit

List all available ePDU CLI commands

```
pdu#0>?
```

Example

```
pdu#0>?
Usage: ? info get set pdu quit
pdu#0>
```

List detailed help on a specific ePDU CLI command

```
pdu#0><command> ?
```

Example 1

```
pdu#0>set ?
Usage: change the device data defined by its' name followed by the new value set
[name] [value]
pdu#0>
```

Example 2

```
pdu#0>pdu ?
Usage: select the strapping pdu unit to focus on pdu [number]
PDU#0
```

info command

Use this command to display the device data defined by its name information (`info [name]`).

```
pdu#0>info ?
      info [System]
      info [Network]
      info [User]
      info [Access]
      info [Time]
      info [eMail]
      info [SNMP]
      info [NetworkManagement]
      info [EnergyWise]
      info [DaisyChain]
      info [UserDefinedGroup]
      info [PowerSchedule]
      info [Summary]
      info [Input1]
      info [Input2] NOTE 1
      info [Gang]
      info [Outlet]
      info [Environment]
```

```
pdu#0>
```

NOTE 1: On Dual Input ePDU only.

Usage

```
pdu#0>info <object>
```

where:

<object> = name of a simple object, an object of type array or a family of objects

Example 1

```
pdu#0>info System.Network.DHCP
```

<u>Name</u>	<u>Unit</u>	<u>RO/RW</u>	<u>Type</u>
System.Network.DHCP	RW		0: Disabled 1: Enabled

Example 2

```
pdu#0>info PDU.*
```

<u>Name</u>	<u>Unit</u>	<u>RO/RW</u>	<u>Type</u>
PDU.DaisyChain[x].ChangedStatus.CommunicationLost	sec	RO	Integer:0..4294967295(136 years)
PDU.DaisyChain[x].iName	sec	RO	String[15]
.			
.			
.			
PDU.DaisyChain[x].PresentStatus.CommunicationLost	sec	RO	0: Normal 1: Alarm

Example 3

```
pdu#0>info System.*
```

<u>Name</u>	<u>Unit</u>	<u>RO/RW</u>	<u>Type</u>
System.NetworkManagementSystem.Count		RO	Integer:0..65535
System.NetworkManagementSystem[x].HostName		RW	String[63]
System.NetworkManagementSystem[x].TrapCommunity		RW	String[24]
.			
.			
.			
System.NetworkManagementSystem[x].TrapSnmpVersion		RW	0: Disabled 1: SNMP V1 2: SNMP V3

Example 4

```
pdu#0>info Environment.*
```

<u>Name</u>	<u>Unit</u>	<u>RO/RW</u>	<u>Type</u>
Environment.ChangedStatus.CommunicationLost	sec	RO	Integer:0..4294967295(136 years)
Environment.ChangedStatus.OverHumidity	sec	RO	Integer:0..4294967295(136 years)
Environment.ChangedStatus.OverTemperature	sec	RO	Integer:0..4294967295(136 years)
Environment.Humidity		RO	Float:0..6553.5
Environment.Input[1].ChangedStatus.Alarm	sec	RO	Integer:0..4294967295(136 years)
Environment.Input[1].iName		RW	String[31]
.			
.			
.			
Environment.Input[1].PresentStatus.Alarm		RO	0: Normal 1: Alarm

quit command

Use this command to log out and exit the serial or network interface for the ePDU.

Usage

```
pdu#0>quit
```

Log out of the CLI

```
pdu#0>quit
```

Example with serial interface

```
pdu#0>quit
Session closed
```

Example with network interface

```
pdu#0>quit
Connection to host lost.
```

get command

Use this command to view the value of an object or a family of objects that belong to the HID database or a card parameter.

Usage

```
pdu#0>get <object>
```

where:

<object> = a simple object, an object of type array or a family of objects

Get a single value

```
pdu#0>get <path>.<name>
```

Example

```
pdu#0>get System.Network.DHCP
1
pdu#0>
```

Get the size of an array

```
pdu#0>get <path>.Count
```

Example

```
pdu#0>get System.NetworkManagementSystem.Count
8
pdu#0>
```

Get a single value of an array

```
pdu#0>get <path[i]>.<name>
```

where:

[i] = the index in the array, from 1 to *n*. The value of *n* depends of the HID object and is obtained with a **get** command

Example

```
pdu#0>get System.NetworkManagementSystem[1].TrapCommunity
public
pdu#0>
```

Get all values of an array

```
pdu#0>get <path[x]>.<name>
```



NOTE Values are separated by the pipe character (|).

Example

```
pdu#0>get System.User[x].SecurityRight
0|0|0|0|0|0|0|0|0
pdu#0>
```

Get all values of a family

```
pdu#0>get <short path>.*
```

where:

<short path> = incomplete path name. A node must be complete.

Example 1**Example 2**

```
pdu#0>get System.*
System.NetworkManagementSystem.Count
8
System.NetworkManagementSystem[x].HostName
../..
pdu#0>
```

Get Daisy-chained ePDU to Supervise or Retrieve Communication Status

```
pdu#0> pdu [x]
pdu#0>get <short path>.*
```

where:

[x] = value 0 to 7 to indicate Host (0) or device (1, 2, 3, 4, 5, 6, or 7) to supervise; enter key to accept prompt ePDU ID
 <short path> = incomplete path name. A node must be complete.

Example 1

```
pdu#0>get System.DaisyChain.*
System.DaisyChain.DeviceId
0
System.DaisyChain.Position
1
System.DaisyChain.Status
1
System.DaisyChain.Count
1
pdu#0>
```

NOTE 1 The communication status is returned for the selected Device or Host by `System.DaisyChain.Status`. The Status value is:



0: No Communication
 1: Communication OK
 2: Communication failed
 3: Host conflict
 4: Device conflict

NOTE 2 The Count command value is the number of ePDUs connected in the daisy-chain configuration.

set command

Use this command to change the value of an object that belongs to the HID database or a card parameter.



NOTE Some data cannot be modified without appropriate user access rights.

Usage

```
pdu#0>set <object> <value>
```

where:

<object> = a simple object or an object of type array.

<value> = a value or a list of values separate with the pipe character (|). For a value of type string, the space character ' ' is taken into account.

Set a single value

```
pdu#0>set <path>.<name> <value>
```

Example 1

```
pdu#0>set System.Network.DHCP 1
1
pdu#0>
```

Example 2

```
pdu#0>set System.Display.LcdRotation 1
1
pdu#0>
```

where:

- <0> = Rotation 0 Degrees (0U).
- <1> = Rotation 90 Degrees (IL).
- <2> = Rotation 180 Degrees (0U).
- <3> = Rotation 270 Degrees (IL).

Set value of an array

```
pdu#0>set <path[i]>.<name> <value>
```

where:

[i] = the index in the array, from 1 to *n*. The value of *n* depends of the HID object and is obtained with a **get** command

Example

```
pdu#0>set System.Network.SNMP.V3.User[1].Name User 1
User 1
pdu#0>
```

set all values of array

```
pdu#0>set <path[x]>.<name> <value 1>[|<value 2>]..../..[|<value n>]
```



NOTE Values are separated by the pipe character (|).

Example

```
pdu#0>set System.Network.SNMP.V3.User[x].Name User 1|User 2|User 3|User 4
User 1|User 2|User 3|User 4
pdu#0>
```

Set Daisy Chain**Device ID and Position**

```
pdu#0>set System.DaisyChain.DeviceID [x]
```

where:

[x] = value from 1 to 7 as a unique identifier for each device (zero is reserved for the Host)

```
pdu#0>set System.DaisyChain.Position [x]
```

where:

[x] = 0 for a device ePDU connected between two other ePDUs; 1 for a device ePDU connected to just one ePDU

Example

```
pdu#0>set System.DaisyChain.DeviceID
1
pdu#0>
```

```
pdu#0>set System.DaisyChain.Postion 1
1
pdu#0>
```

Host ID and Position

```
pdu#0>set System.DaisyChain.DeviceID [x]
```

where:

[x] = enter 0 as a unique identifier for the host only

```
pdu#0>set System.DaisyChain.Position [x]
```

where:

[x] = 0 if the host ePDU is connected between two other ePDUs; 1 if the host ePDU is connected to just one ePDU

Example

```
pdu#0>set System.DaisyChain.DeviceID 0
0
pdu#0>
```

```
pdu#0>set System.DaisyChain.Postion 1
1
pdu#0>
```

pdu command

Use this command to access different ePDUs on the daisy chain, or to reset a daisy-chained ePDU as the Host or Device.

Usage

```
pdu#0>pdu <value>
```

where:

<value> = 0 for the host; 1, 2, 3, 4, 5, 6, or 7 for the device

Example

```
pdu#0>pdu 1
pdu#1>
```

Error Messages

The following errors could display:

The command is unknown.

This error displays when an invalid command is entered. Valid commands are ?, info, get, set, pdu, and quit.

The parameter in the command is unknown.

This error displays when a parameter you entered in the command is not recognized.

The parameter in the command is out of limits.

This error displays in the following circumstances:

- The set command refers to a data name but does not have the second parameter.
- The set command refers to a value that does not match with the data.

The command is not valid for this object.

This error displays when the set command refers to an object that cannot be set after the system preforms a coherence check with other data.

The user has insufficient rights.

This error displays when:

- The set command contains read-only data.
- The user has insufficient rights to modify the data.

The PDU1 is not available.

This error displays when the indicated PDU is unreachable.

XML Object Tables

XML object tables are available online at www.eaton.com/epdu.

Chapter 8 Web Interface Operation

This chapter describes remotely configuring, managing, and monitoring an Eaton Enclosure Power Distribution Unit (ePDU) G3 remotely through the ePDU Network Management and Control (eNMC) module Web interface. This chapter describes the following:

- Navigating the Web interface
- Accessing the Web interface
- Configuring settings and monitoring the ePDU



NOTE

When the Web browser is set to 100% (full page), we recommend setting your screen resolution to a minimum of 1024 x 768 for the best display performance.

Navigating the Web Interface

The graphical Web interface is used to remotely monitor or configure the ePDU (see Figure 87). The Web interface that corresponds to the ePDU topology type displays. This section describes the functions provided by this interface.

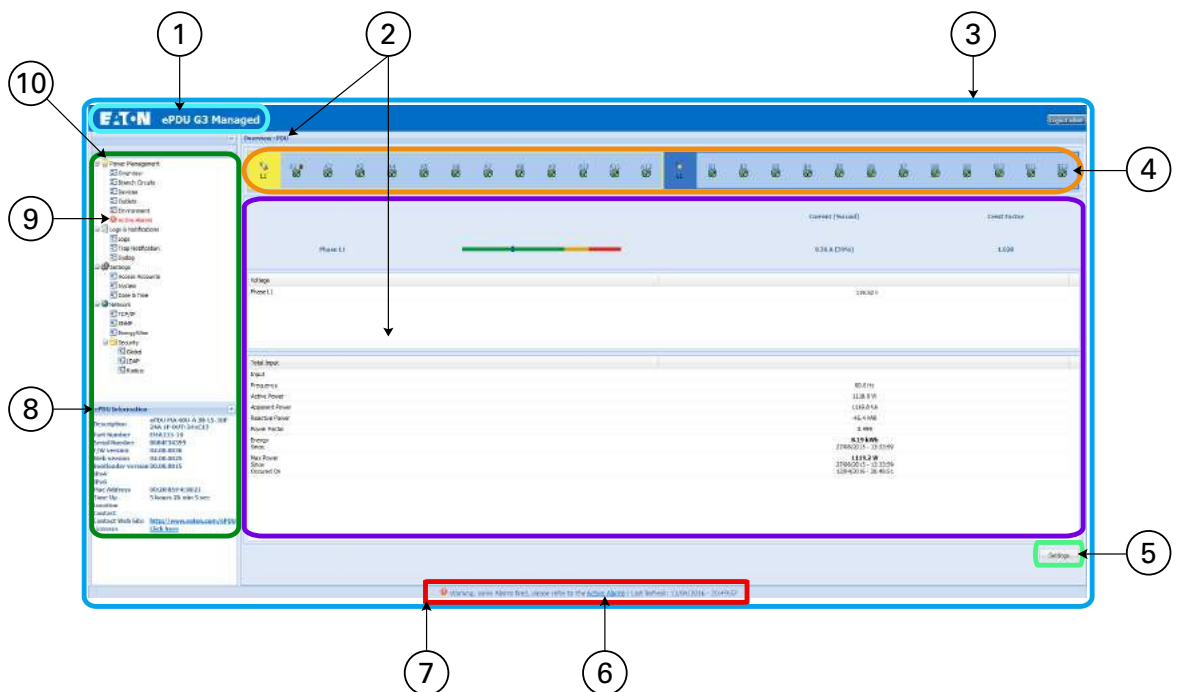

Figure 87. Navigating the Web Interface (Opening Page)

Table 8 provides descriptions of the Web interface components.

Table 8. Web Interface Region Descriptions







Area	Description
1 - Application Header Bar	The header bar identifies which Eaton ePDU Web application is within the host window (Managed [MA], Metered Input [MI], Metered Outlet [MO], In-Line Metered [IL], or Switched [SW]).
2 - Menu Selection Page Display	<p>As each menu link is selected, the corresponding information displays as the main page. The top of the page displays the menu selection title.</p> <p>NOTE You can expand your view of the contents vertically using the elevator scroll button on the side of the page. If you need more window viewing area, resize the Host Window to a wider or taller size. This enlarges the main page.</p>
3 - Host Window	The host window is the page where the application resides. Both the height and the width of the host window can be resized. The application panels resize at the same time. An elevator scroll button displays on the side of the application panel if the panel cannot display the entire list within the resized panel. Drag the elevator scroll button up or down to view the entire list of data in the application panel.
4 - Outlet Icons	<p>Roll over any outlet icon to see the type of outlet and whether there is an alarm. (A gray outlet status indicates that the outlet management feature could be damaged.)</p> <p>Outlet is Off</p>  <p>Outlet is on</p> 
5 - Operation Buttons and Icons	Operation buttons and icons are provided to save data entries and updates. Enter data by typing or selecting entries and clicking the associated button. Some pages have buttons for specialized functions, such as clearing accumulated data logs. File operation icons are also provided to save or download files.
6 and 7- Current Alarms (when active)	<p>An indicator appears as a notification in the refresh bar at the bottom of the page. For example, "Warning, some alarms fired, please refer to the Active Alarms Last Refresh: dd/mm/yyyy - hh:hh:ss"</p> <p>The words "Active Alarms" in the alarm notification sentence link to the Active Alarms page.</p> <p>The following symbols indicate the alarm level when an alarm threshold setting is exceeded:</p> <p>Active Alarms Present</p>  <p>High Critical Threshold Alarm</p>  <p>High Warning Threshold Alarm</p>  <p>Low Warning Threshold Alarm</p> 

Table 8. Web Interface Region Descriptions (Continued)

Area	Description
8 - ePDU Information	This panel displays identification information for the ePDU that is providing data. The data fields include information about the ePDU, including a model description, part number, serial number and the current ePDU firmware version in use. NOTE For daisy-chained ePDUs, you can select either ePDU [0] for Host data and ePDU [1], [2], [3], [4], [5], [6], or [7] for Device data.
9- Active Alarms Menu Selection	This indicator alerts you to the presence of currently active system alarms. It is in the menu hierarchy. When alarms are active, the text for Active Alarms is red. Selecting Active Alarms opens the Active Alarms page and displays the current active alarms.
10 - Menu Bar	The menu bar on the left panel contains links to pages for configuring the system or managing and monitoring the ePDU. The menu hierarchy is expandable and collapsible. You can move the menu bar out of view using the horizontal scrolling tab at the bottom of the page. Click any selection in the menu bar to retrieve ePDU performance data, review operation log information, or retrieve system or network configuration settings. The data on the selected page is presented in table format.

NOTE 1 The data that displays on the Web interface depends on the ePDU model you are using. For example, a dual reporting window displays data for Input 1 and for Input 2 when the ePDU has two inputs. In this chapter, the examples shown represent typical data displays reported from a single-input model.



NOTE 2 The Web interface supports Microsoft® Internet Explorer® 8.0 and greater, Firefox® (installed on Linux® or Windows®), and Google® Chrome®.

NOTE 3 On most pages, you can display relevant tooltips as you roll over images and fields.

Languages

The Web interface language is configurable. The following languages are available for your selection:

- English
- French
- Spanish
- German
- Italian
- Chinese Simplified
- Japanese
- Korean
- Chinese Traditional
- Polish
- Portuguese
- Czech

Accessing the Web Interface

The Web interface can be accessed using a standard Web browser.

**NOTE**

The ePDU defaults to using DHCP when delivered. If you are unable to connect to the ePDU through the network connection with this default address, see “Network Communication Configuration” on page 56 for more information.

To access the Web interface:

1. Open the Web browser.
 2. Enter a new ePDU IP address or select the previously entered ePDU IP address from the URL address drop list. The Authentication dialog displays.
 3. Enter a valid user name and password in the Authentication dialog box (see Figure 88). Click **Login** to continue or **Cancel** to exit.
-

**NOTE**

The default user name is “admin” and the default password is “admin.”

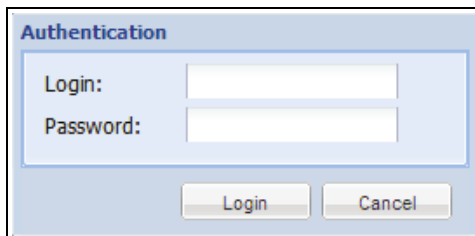

The image shows a screenshot of a web browser's authentication dialog box. The dialog is titled "Authentication" in blue text. It contains two input fields: "Login:" and "Password:". Below the input fields are two buttons: "Login" and "Cancel".

Figure 88. Login Authentication

4. The ePDU Overview page displays.
5. To access another page to observe and control the ePDU, click any selection in the menu bar. The page that corresponds to your menu selection opens and displays in the main selection page window.

Menu Selections

Depending on the permission level of the user, the Menu Bar provides up to four groups of selections:

- Power Management
 - Overview
 - ePDU [0] See NOTE 1
 - ePDU [1] See NOTE 1
 - ePDU [2] See NOTE 1
 - ePDU [3] See NOTE 1
 - ePDU [4] See NOTE 1
 - ePDU [5] See NOTE 1
 - ePDU [6] See NOTE 1
 - ePDU [7] See NOTE 1
 - Branch Circuits
 - Devices
 - Outlets
 - Environment
 - Active Alarms
- Logs and Notifications
 - Logs
 - Trap Notification
 - Syslog
- Settings See NOTE 2
 - Access Accounts
 - System
 - Date & Time
- Network
 - TCP/IP
 - SNMP
 - Energy/Wise
 - Security
 - Global
 - LDAP
 - RADIUS

NOTE 1 Menu selections for ePDU [0], [1], [2], [3], [4], [5], [6], or [7] only display if the ePDUs are configured in a daisy-chained configuration. If provided, selecting either ePDU [0] or ePDU [1], [2], [3], [4], [5], [6], or [7] displays the Overview page for the specified ePDU only.



NOTE 2 The Settings menu is different from the Settings button. Selecting the **Settings** button on any power management page displays a separate window that allows you to change settings, such as alarm thresholds.

NOTE 3 See “Access Privileges” on page 98 for more information about levels of access privileges.

Power Management

Use the Power Management menu selections to see up-to-date operating measurements on the ePDU Overview page. This page provides the present readings for the ePDU that is reporting data. (If ePDUs are daisy-chained, you can select to see Host or Device ePDU Information.) The readings are reported per phase and, for 3Ph ePDU models, all phases. This page includes data such as current, voltage, and crest factor. The outlet icons are green if the outlet is on and red if the outlet is off. Roll over the icon to see the outlet type and status.

The Outlets page provides present measurements or readings such as current or active power. You can set measurement thresholds for alarm or warning notifications as well. You can also set power schedules for outlets.

On the Outlet Settings dialog, the Power Schedule section allows you to schedule automatic power On, power Off, or Reboot actions for selected outlets. These schedules can be set for a single instance, daily or weekly activity at specified time intervals.

The Environment menu selection provides humidity and temperature data if you have an EMP installed. You can set measurement thresholds for alarm or warning notifications as well. It also provides open or closed status for two dry contacts.

You can check current alarms on the Active Alarms page to see a list of alarms by date, time, and description. See “Maintenance and Alarms” on page 135 for a list of alarms.

Logs & Notifications

Use the Logs & Notifications menu selections to see a list of the most recent events (Logs page). You can set trap receivers (Trap Notification page) and you can also view Syslog information.

Settings

The Settings menu selections that display depend on the type of privilege you have. These selections allow you to configure administrative settings, system attributes, and network access and control. Depending on privilege, this menu can include the following:

- **Access Accounts:** The Access Accounts page allows you to set up the SuperUser, local or remote administrators, local ePDU-users and Outlet-users, and remote ePDU-users and Outlet-users as individuals or groups. Access Accounts also allows the SuperUser to set up the LCD password.
- **System:** Use the System selection for identifying the administrator contact information, uploading an ePDU or ePDU Network Management and Control (eNMC) module configuration file, upgrading, restarting, or restoring factory default configuration to the ePDU eNMC module. You can also reset the language and configure reporting for the EMP.
- **Date & Time:** The Date & Time page allows you to select the date format and set the date and time, either manually or by synchronizing with the Network Time Protocol (NTP) server. You can set the time zone and have the option of allowing Daylight Savings Time (DST).

Network

This selection allows you configure TCP/IP, SNMP, and Security settings for this ePDU.

- **TCP/IP:** Use this page to configure Ethernet, IPv4, IPv6, DNS, and SMTP.
- **SNMP:** Use this page to configure general SNMP settings, SNMPv1 settings, and SNMPv3 settings. You can also access the Eaton ePDU Management Information Base (MIB) from this page.
- **Energy/Wise:** Use this page to enable or disable the Energy Wise feature.
- **Security:** Use this page to set port settings and Lightweight Directory Access Protocol (LDAP) settings.
 - **Global:** Set the port settings and the authentication mode on this page.
 - **LDAP:** Set the LDAP search configuration and global LDAP server global parameters for the specified LDAP servers on this page.
 - **RADIUS:** Add or edit the parameters for a primary or secondary RADIUS server on this page.

Access Privileges

The level of access privilege determines what the user will see and what actions the user can perform. For example, the level of access privilege determines which menu items the user can access or which fields display on individual setting and configuration dialogs. Any menu or dialog functions that are not included in the access privilege set for a user do not display, or are they are grayed-out.

These accounts can be configured not only for individuals, but also for groups. All remote users and administrators belong to a remote group and their access privileges are defined from this group. Remote accounts also provide a way to attach LDAP users (see “Configure Remote Group Access” on page 119).

Three user roles can be assigned these access privilege levels:

- Administrator
- Local or Remote ePDU-User
- Local or Remote ePDU-User/Outlet User

Administrator

There can be one SuperUser and up to eight standard local or remote administrators.

Only one user can be the SuperUser Administrator. This defaults to the local user, but a SuperUser should be assigned at first connection. This account is not accessible or editable by the standard administrators or ePDU-Users/Outlet Users. The SuperUser always has read-write privileges to view and edit all data, plus the following privileges restricted only to the SuperUser:

- Exclusive access to modify the SuperUser account settings
- Can upload the communication module configuration file or upgrade the firmware
- Can access both the Serial interface and the Web interface
- Exclusive access to the Network and Date and Time Settings menu



NOTE

The default Administrator login and password is “admin” and should be changed at the first connection. If the administrator loses the password or login, contact your service representative to recover it.

Local or Remote Administrator

Up to eight standard administrators (local or remote) can be assigned. Only accessible menu items display for the user according to the assigned permissions.



NOTE

This menu indicates the two ePDU are daisy-chained, one host (ePDU [0]) and one device ePDU (ePDU [1]).

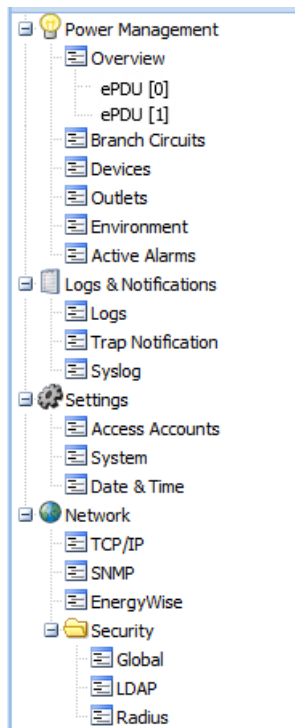

Figure 89. Administrator Menu View

Read-Write Access

A local or remote administrator who is assigned read-write access can perform the following:

- Access to up-to-date ePDU data and measurements
- Create, modify, or disable an administrator or user account except for the SuperUser
- Create, modify, or disable User-Defined Groups
- Configure e-mail recipient addresses for e-mail notification to users
- Restart the communications module
- Cannot access the Serial interface; must use the Web interface only
- Access all menus on the Web interface
- Access to retrieved ePDU up-to-date data and measurements
- Clear logs
- **Local Administrator Only.** Can switch on bootloader mode and upgrade firmware

Read-Only Access

A local or remote administrator with read-only access has limited privileges, including:

- Access to up-to-date ePDU data and measurements
- Has the authority to change the password, but not the login (Remote ePDU-Users cannot change the login or password)
- Cannot access the Serial interface; must use the Web interface only
- Can access the log and notifications submenu, but cannot clear the logs data
- Cannot configure the TCP/IP, SNMP Global Security, and LDAP settings

No Access

An administrator with no access is not authorized to access to the Web page.

ePDU-User**Read-Write Access**

A local or remote ePDU-User with read-write access privileges has access to the same functions as the administrator, except this user cannot change the account configuration for another user, such as e-mail addresses for notifications.

Only accessible menu items display for the user according to the assigned permissions.

**NOTE**

This menu indicates the two ePDU are daisy-chained, one host (ePDU [0]) and one device ePDU (ePDU [1]).

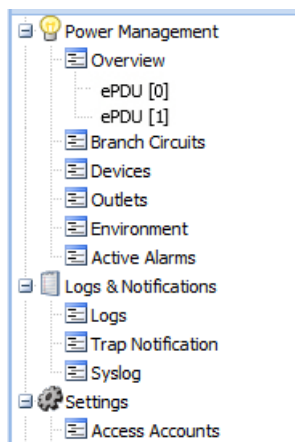

Figure 90. ePDU-User Menu View

Read-Only Access

An ePDU-User with read-only access has limited privileges, including:

- Access to up-to-date ePDU data and measurements
- Has the authority to change the password and e-mail address, but not the login (Remote ePDU-Users cannot change the login or password, but can change their own e-mail address.)
- Cannot access the Serial interface; must use the Web interface only
- Can access the log and notifications submenu, but cannot clear the logs data
- Cannot configure the TCP/IP, SNMP Global Security, and LDAP settings
- Cannot upload the communication module configuration file or upgrade the firmware
- Cannot change his profile or another user's account

No Access

An ePDU-User with no access privileges is not authorized to access to the Web page.

Outlet-User

The Outlet-Users have only one read-write privilege. The Outlet-User has the authority to change his own password and e-mail address, but not the login. (Remote Outlet-Users cannot change the login or password, but can change their own e-mail address.) All other privileges are restricted to viewing ePDU and assigned outlets data. Only accessible menu items display for the user according to the assigned permissions.

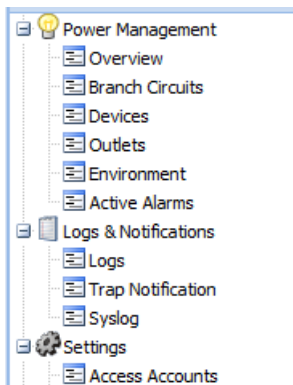

Figure 91. Outlet-User Menu View

Read-Only Access

Outlet-Users with read-only access have limited privileges, including:

- Access to retrieved ePDU up-to-date data and measurements, but cannot change settings for the ePDU
- Access to retrieved data for the outlets in user-defined groups assigned by the administrator
- Cannot access the Serial interface; must use the Web interface only
- Can access the log and notifications submenu, but cannot clear the logs data
- Cannot configure the TCP/IP, SNMP Global Security, and LDAP or other global settings
- Cannot upload the communication module configuration file or upgrade the firmware
- Cannot change his profile or another user's account

No Access

An Outlet-User (local or remote) with no access privileges is not authorized to access to the Web page.

Session Management

The following session management restrictions apply:

- There can only be one SuperUser with read-write access rights and up to eight multi-users with configurable access rights.
- Only one ePDU-User or Outlet User with read-write access and at least one common outlet can be logged-in at a time.
- When the administrator connects, any existing read-write sessions are closed. The other user (or users) will be asked to authenticate and open a new read-only session.
- If a user with read-write access is logged in and another user with read-write access wants to log in, the following message displays: "Another user is logged in with R/W access. Continue as R/O?"
- ePDU sessions are also limited in the following ways:
 - Only five standard sessions without Secure Sockets Layer (SSL) or Secure Shell (SSH) sockets are allowed.
 - Only two secure sessions can be running at the same time.
 - Only an administrator can have two simultaneous sessions open in Hypertext Transfer Protocol / Hypertext Transfer Protocol Secure (HTTP/HTTPS), Telnet/SSH.



NOTE

During an HTTP/HTTPS or Telnet/SSH session, the session times out if there is no activity for five minutes. After a session times out, you must login again.

Overview

Review/Modify ePDU Data



NOTE

Menu selections for ePDU [0], [1], [2], [3], [4], [5], [6], or [7] only display if the ePDUs are configured in a daisy-chained configuration. If provided, selecting either ePDU [0] or ePDU [1], [2], [3], [4], [5], [6], or [7] displays the Overview page for the specified ePDU only.

1. Access the Web interface and log in.
2. The PDU: Overview page displays.
3. In the ePDU Information panel, review ePDU identification information.
4. In the main page, review ePDU monitoring data.



NOTE 1

The phase information that displays reflects the ePDU model. For example, the number of phases that display depends on whether the ePDU is a single-phase, split-phase, or three-phase model. The phase labels also change depending on whether the model is a delta-wired or a wye-wired model.

NOTE 2

Roll the cursor over an outlet icon to see the type of outlet and the status (On or Off).

5. To modify ePDU voltage and current threshold values, click the **Settings** button. The Settings dialog displays.

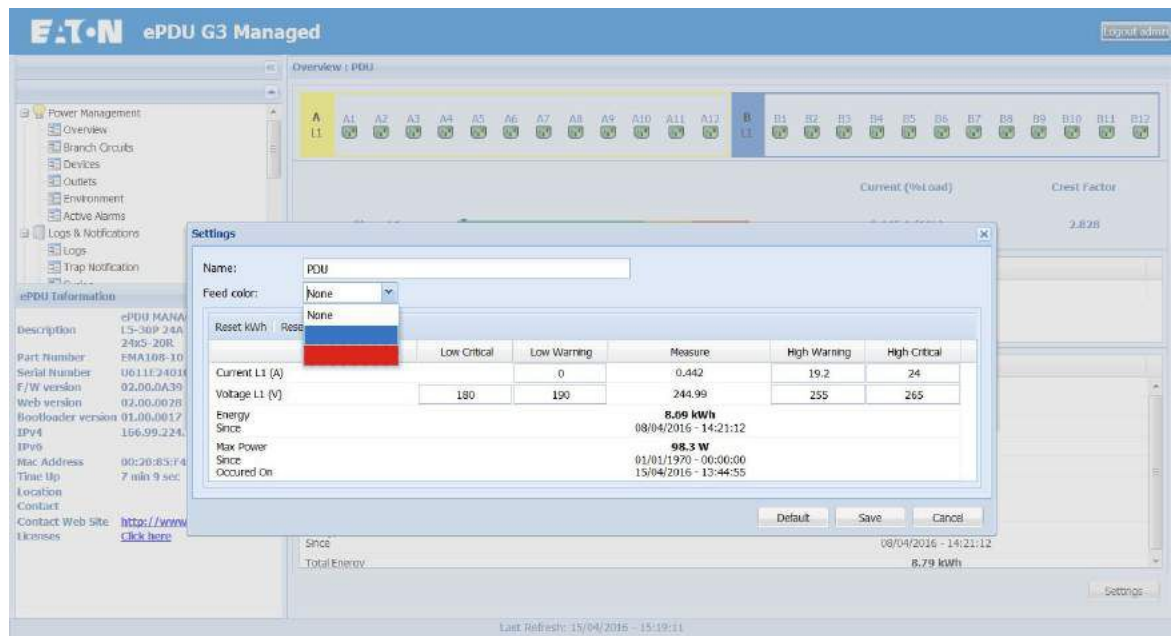

Figure 92. ePDU Voltage and Current Threshold Values Settings



NOTE Select a color for the input feed of an ePDU by selecting the drop-down menu of the Feed color field. This color is displayed for the tag on the left of the section.

6. To enter new threshold values, type new values in any of the text boxes that follow, then click **Save**:
 - Low warning current threshold
 - High warning current threshold
 - High critical current threshold
 - Low critical voltage threshold
 - Low warning voltage threshold
 - High warning voltage threshold
 - High critical voltage threshold
7. To reset the threshold values to the default values, click **Default**, then click **Save**.
8. To reset a kWh (kilowatt hour) counter to zero, click **Reset kWh**, then click **Save**.



NOTE If you do not save the action, the kWh counter remains unchanged.

9. To reset the maximum power counter to zero, click **Reset Max Power**, then click **Save**.
10. To cancel this action and return to the Overview page, click **Cancel**.

Branch Circuits



NOTE All sections, with or without breakers, are displayed.

Review Branch Circuits

1. Access the Web interface and log in.
2. Under Power Management, select **Branch Circuits**. The Branch Circuits main page displays.
3. In the main page, review the status of the sections:
 - You can see additional section details by clicking the red arrow next to the current percentage value in the Current (%Load) column, or double-clicking the row.
 - Specific outlet details are available when you roll over the outlet icons. Green icons mean that the outlet is ON.
 - Red icons mean one of the following conditions exists for the outlet:
 - At least one outlet is off
 - At least one outlet status is unknown
 - Communication is lost.
 - At least one outlet status is unknown and communication is lost.
4. To change settings for all sections associated with the PDU, check the checkbox next to the PDU name. Otherwise, check the checkbox beside the section name to change individual section settings. This selects the section or sections to which you will apply changes.

Change Groups Measurements Settings

1. Access the Web interface and log in.
2. Under Power Management, select **Branch Circuits**. The Branch Circuits main page displays.
3. To change measurement settings, select a section or sections and click **Groups measurement settings** in the top row of the page. The Groups measurement settings dialog displays.
4. To enter new threshold values, type new values in any of the text boxes that follow, click **Apply** and then click **Save**:
 - Low warning current threshold
 - High warning current threshold
 - High critical current alarm threshold
 - Low critical voltage threshold
 - Low warning voltage threshold
 - High warning voltage threshold
 - High critical voltage threshold
5. You can reset the total energy and the peak current of the selected sections. Click **Reset kWh** or **Reset max currents** to issue these commands:
 - **Reset kWh**: Resets the total cumulative energy of the sections and updates the date.
 - **Reset max currents**: Resets the peak current and updates the date for the PDUs that belong to this section.
6. Click **Save** to save the settings that were reset.

Turn Sections On or Off

1. Access the Web interface and log in.
2. Under Power Management, select **Branch Circuits**. The Branch Circuits main page displays.
3. To turn sections off or on with the selected expediency, check a checkbox a section or sections and select a setting from the **Turn On/Off sections** drop-down list in the top row of the page:
 - **On:** Immediately switch on the outlets of the selected groups.
 - **Immediate Off:** Immediately switch off the outlets of the selected groups.
 - **Delayed Off:** Switch off the outlets of the selected groups after a delay (set in the Outlet settings menu).
 - **Delayed Reboot:** Switch off the outlets of the selected groups after the switch-off delay, and then switch on after the reboot period. The switch-off delay and the reboot period are set in the Outlet settings menu.
4. A pop-up message asks if you are sure you want to switch the selected section on or off. Click **Yes** or **No**.
5. If Yes, a message pops up indicating that your changes were saved.

Change Individual Section Settings

1. Access the Web interface and log in.
2. Under Power Management, select **Branch Circuits**. The Branch Circuits main page displays.
3. To change individual section settings, click the section name. The Branch Circuit Settings dialog displays.
4. To enter new threshold values, type new values in any of the text boxes that follow, then click **Save**:
 - Low warning current threshold
 - High warning current threshold
 - High critical current alarm threshold
 - Low critical voltage threshold
 - Low warning voltage threshold
 - High warning voltage threshold
 - High critical voltage threshold
5. To reset the threshold values to the default, click **Default** and then **Save**.
6. You can reset the total energy and the peak current of the selected sections. Click **Reset kWh** or **Reset max currents** to issue these commands:
 - **Reset kWh:** Resets the total cumulative energy of the sections and updates the date.
 - **Reset max currents:** Resets the peak current and updates the date for the PDUs that belong to this section.
7. Click **Save** to save the settings that were reset.

Devices

Rules for Devices

The following rules for Devices apply:

- A maximum of 32 Device Groups can be defined.
- A device can be connected to a maximum of two PDUs.
- A device can be connected to a maximum of six outlets per PDU, unless two PDUs are daisy-chained. In this case, outlets can belong to a maximum of two daisy-chained PDUs
- At the top of the outlets settings grid, a warning advises about this limit. If the limit is reached, all unchecked outlets in the PDU column are disabled.
- An outlet can only be connected to one device at the same time. Already connected outlets are disabled in the grid.
- Some measures and some actions are available on each Device Group and others are specifically available on each PDU that belongs to the Device Group.
- Users cannot select the same PDU in the two columns of the Outlets settings grid. If users select the same PDU in the first column that was selected in the second column, then the previous PDU that was defined in the first column will be set in the second column.
- Saving a device with outlets from an unknown PDU will display outlet numbers in red to show a connection failure.
- If a PDU is not daisy-chained, outlet settings grid will display only one PDU column when adding a new device.
- If a PDU is not daisy-chained, but users display settings of a device connected to two PDUs, the outlet settings grid will display the two PDU columns.
- Clicking **Apply** does not save data; only clicking **Save** will save your changes.

Review Devices

1. Access the Web interface and log in.
2. Under Power Management, select **Devices**. The Devices main page displays.
3. In the Devices panel, review the status of the devices. Note that the green circle with a check indicates that all outlets are on. The red circle with an exclamation mark indicates one of the following:
 - At least one outlet is off
 - At least one outlet status is unknown
 - Communication is lost.
 - At least one outlet status is unknown and communication is lost.
4. To see which condition applies, roll over the red circle with an exclamation mark.

NOTE 1 On the main Device page, the measurements that display are the sum of instantaneous measurements obtained on each outlet.



NOTE 2 For energy, the reference date is either the date when the group was created or the date when the user reset its' energy.

5. Click the checkbox next to the device name or double-click the row to see load-balancing details about this device, including the outlet status, the gauge of the instantaneous current, and the peak current (see Figure 93).

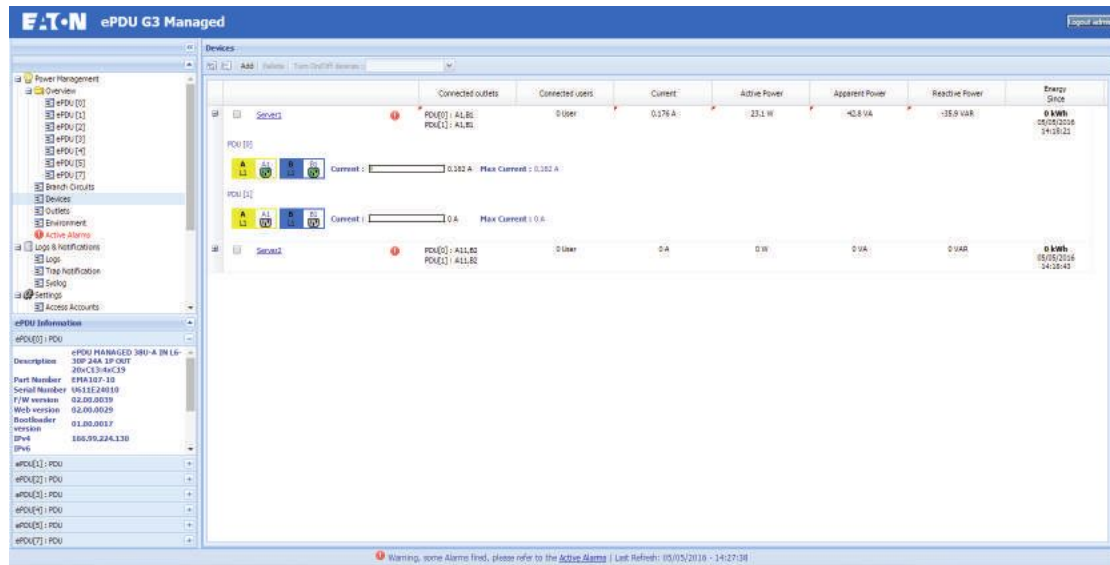

Figure 93. Expand Load-Balancing Details on Row for Device

NOTE 1 Use the cursor to roll over outlet data in the row load-balancing details display to see additional information. For example, in the load balancing panel, a tooltip containing complementary information concerning outlets is displayed when you roll over the outlet images.

NOTE 2 The display may be highlighted with a red color if:

- If there is a connection failure on a PDU, problems are highlighted in red numbers above the outlet image to locate their position in the unknown PDU.
- Some load balancing value can be wrong if related PDU has out-of-date firmware. These values are highlighted in red and display a tooltip.

NOTE 3 Note that only 32 devices are allowed, so the **Add** button is grayed-out (unavailable) when the maximum number of devices are listed.

NOTE 4 Perform an action on several devices at the same time by selecting the applicable device checkboxes and clicking the action button in the bar above the window.

Add Devices

Connected outlets are outlets that power the given device. To identify those outlets, initially select the PDU to which they are connected. (In a Daisy chain, you can chose from up to eight PDUs. In a setup with no daisy-chained PDUs, but just a single unit, only one selection value is provided.)

For example, when you have at least two daisy-chained PDUs, two columns display, allowing you to select two supporting PDUs and the two corresponding check boxes lists. Then, you check the boxes corresponding to the outlets powering the device your are defining.

To add devices:

1. Access the Web interface and log in.
2. Under Power Management, select **Devices**. The Devices page displays.
3. Click **Add** in the top bar of the page. The Device Settings dialog displays.

4. Type the name in the **Name** field (31 characters maximum).
5. In the Connected outlets panel, select the PDU that the device is plugged into.
6. Select the outlets in each PDU (unavailable outlets are grayed-out).
7. Select the power schedule of the device in the Power Schedule area.
8. Click **Save**. A message displays to alert you that if a Power Schedule was previously defined on outlets in the Outlets settings menu, that Power Schedule will be overwritten. The new device name displays after a refresh.

Delete Devices



NOTE It is recommended that you delete device groups when they are no longer used.

1. Access the Web interface and log in.
2. Under Power Management, select **Devices**. The Devices page displays.
3. In the Devices panel, select the checkbox associated with one or more device groups.
4. Click **Delete**.
5. Click **Save**.

Turn Devices On or Off

1. Access the Web interface and log in.
2. Under Power Management, select **Devices**. The Devices page displays.
3. In the Devices panel, check the checkbox associated with one or more device groups.
4. Select one of the following actions from the drop-down list beside **Turn on/off devices**:
 - **Turn on**: Immediately switch on the devices of the selected groups.
 - **Turn Immediate Off**: Immediately switch off the devices of the selected groups.
 - **Turn Delayed Off**: Switch off the devices of the selected groups after a delay (set in the Outlet settings menu).
 - **Turn Delayed Reboot**: Switch off the devices of the selected groups after the switch-off delay, and then switch on after the reboot period. The switch-off delay and the reboot period are set in the Outlet settings menu.
5. A pop-up message asks if you are sure you want to switch the selected section on or off. Click **Yes** or **No**. If Yes, a message pops up indicating that your changes were saved.

Change Device Settings

1. Access the Web interface and log in.
2. Under Power Management, select **Devices**. The Devices page displays.
3. In the Devices panel, click the name of a device or devices. The Device Settings dialog displays.
4. To enable the Power schedule to apply it to this device, check the checkbox for Power Schedule. This indicates that the power schedule is enabled for this device or devices. Unless None is selected for the Action value, you can make changes in the Power schedule fields.

5. In the Action field, select either **On**, **Off**, or **Reboot** from the drop-down list.
 - **None:** The actions in this schedule are not executed. This is the default upon opening this dialog. (You can use this setting to hold the settings for future activation.)
 - **Off:** Select this value to switch off the outlets of the current device according to the corresponding schedule you specify.
 - **On:** Select this value to switch on the outlets of the current device according to the corresponding schedule you specify.
 - **Reboot:** Select this value to switch off and then switch back on the outlets of the current device according to the corresponding schedule setting. The delay between the Off and the On can be set on the Outlet Settings dialog using the **Power Reboot Period** field (see Step 9 on page 111). With this setting, additional actions scheduled by the Further Actions selections are disabled.
6. Set the time schedule for this action by selecting a time from the "at:" drop-down list.
7. Set the days or date of the action using one of the following:
 - If you want to set up a schedule of days for this action, check the **Recurrent**. Check the checkbox next to the name of the days from the "Active Days" drop-down list. (You can exclude some days using this setting.) When settings are saved, the "Date of Action" value is automatically set to the date of the first occurrence of the action.
 - If you want to set a single date to execute an action or further action, uncheck the **Recurrent** checkbox. The Date of Action field and calendar drop-down list displays. Select the date from the calendar.

**NOTE**

"Date of Action" fields are only available when the "Recurrent" checkbox is unchecked. This field specifies the date when the action will be executed, but only once.

8. Click **Save**.
9. **Optional.** You can add additional scheduled actions. For example, suppose your first action is On. You can pair it with a subsequent Off action. The schedule for this second action is set by selecting **Off** from the Further Action drop-down list and setting values in the date and time fields. By default, this second action is set to "None," meaning nothing more will happen.
 - **None:** The actions in this schedule are not executed at the specified time. This is the default if the Action is set to Off or On.
 - **Off:** Select this value to switch off the outlets of the current device according to the corresponding schedule setting.
10. Set the schedule for this action by selecting a date and time from the drop lists for the "at:" and Date of Action" field.

**NOTE**

This date and time must occur after the date and time set for the first action.

11. Click **Save**.
12. If the PDUs do not have a connection failure, you can reset the total energy of the Device Group and the peak current of each PDU Device group. Click **Reset kWh** or **Reset max currents** to issue these commands:
 - **Reset kWh:** Resets the total cumulative energy of the Device Group and updates the date.
 - **Reset max currents:** Resets the peak current and updates the date for the two PDUs that belong to this Device group.

13. Click **Save** to save the settings that were reset.



NOTE If there is a connection failure on a PDU, you cannot reset the device energy value or the maximum currents. The current measurements display in red to indicate that there is a problem with that PDU.

Outlets



NOTE The display varies depending on the profile assigned to the user.

- Switch settings will not display for Metered Outlet (MO) or Metered Input (MI) ePDUs.
- Threshold settings will not display for Switched (SW) ePDUs.
- Only the name of the outlets can be changed for Metered Input (MI) ePDUs.

Review/Modify ePDU Outlets



NOTE This option is only for Switched (SW) and Managed (MA) ePDUs. The On/Off/reboot/last-known state is associated with the "Control" feature for Managed (MA) or Switched (SW) ePDUs.

1. Access the Web interface and log in.
2. Under Power Management, select Outlets. The Outlets page displays.
3. Review basic monitoring information for individual outlets.
4. Click the outlet name to display a dialog for renaming the outlet.
5. To apply an operative action for a selected outlet, select the corresponding checkbox and then select one of the following values from the Turn On/Off drop-down list in the top bar, then click **Save**.
 - **On**: Immediately turn on the selected outlets.
 - **Immediate Off**: Immediately turn off the selected outlets.
 - **Delayed Off**: Turn off the selected outlets after a delay (set on the Outlet settings dialog).
 - **Delayed Reboot**: Turn off the selected outlets after the turn-off delay, and then turn on the selected outlets after the reboot period (the turn-off delay and reboot period are set on the Outlet Settings dialog).
6. To modify ePDU threshold values for a specified outlet, click the link on the group friendly name. The Outlet Settings dialog displays.
7. To set whether an outlet state (On, Off, or Reboot) can be changed, check or uncheck the Enable Switching check box, then click **Save**.
 - **Disabled**: Uncheck the check box to disable the setting, which indicates that the outlet state cannot be changed.
 - **Enabled**: Check the check box to enable the setting, which indicates that the outlet state can be changed.

8. To set the state of the outlet with the ePDU is powered on, select one of the following values from the State on Device Startup drop-down list, then click **Save**:
 - **On**: The outlet is powered after a duration of time set in the Outlet Switch On After field.
 - **Off**: The outlet is not powered.
 - **Last Known State**: The outlet is powered on if it was On when the ePDU was powered Off. Otherwise, the outlet is not powered.
9. **Administrator or User with Read/Write/Control only**. To specify the duration an outlet will be Off before switching On during a reboot, type the number of seconds the outlet should be Off in the Power Reboot Period(s) text box. Click **Save**.



NOTE This setting can be overwritten by the Power Reboot Period defined for groups of outlets on the Group Settings dialog.

10. To enter new threshold values, type new values in any of the text boxes that follow, then click **Save**:
 - Low warning current threshold
 - High warning current threshold
 - High critical current threshold
11. To reset the threshold values to the default values, click **Default**, then click **Save**.
12. To reset a kilowatt hour (kWh) counter to zero, click **Reset kWh**, then click **Save**.

Environment

Configure Environment Sensor Settings

1. Access the Web interface and log in.
2. Under Power Management, select Environment. The Environment page displays.
3. In the Environment panel, review the present ePDU environment monitoring temperature and humidity data. Also review the status of installed dry contacts, open or closed.

NOTE 1 The environmental monitoring data panel only displays data under these circumstances:

- if the EMP is installed and configured in the system
- if the user read-write access rights



NOTE 2 The environmental monitoring data panel displays the value of the last EMP value read as follows:

- When the EMP is disconnected, the startup value will be 0 (zero).
 - When the EMP is first connected, the startup value will be 0 (zero) because the last known reading was taken before a sensor was connected.
 - When the EMP remains connected, the startup value is the last known EMP reading.
-

4. To modify environment threshold values, or to receive alarms when dry contacts change state, click the **Settings** button located in the lower, right-hand corner of the Web interface screen. The Environment Settings dialog displays.



NOTE In the Environment Settings dialog, the measure column displays the present status or state of the dry contacts. This is a read-only column.

-
5. To select default values for thresholds or dry contacts, click **Default**.
 6. To enter new threshold values, type new values in any of the text boxes that follow, then click **Save**:
 - Low critical humidity alarm threshold
 - Low warning humidity threshold
 - High warning humidity threshold
 - High critical humidity alarm threshold
 - Low critical temperature alarm threshold
 - Low warning temperature threshold
 - High warning temperature threshold
 - High critical temperature alarm threshold
 7. To choose if you are notified when a dry contact state changes (Open or Closed), select one of the settings from the drop-down list under Open or Closed for the specified contact, then click **Save**:
 - **Informational**: No alarm is generated.
 - **Alarm**: An alarm is generated when the specified dry contact is Open or Closed.
 8. To reset the threshold values to the default values, click **Default**, then click **Save**.
 9. To cancel this action and return to the Environment page, click **Cancel**.



NOTE To change the temperature scale to Celsius or Fahrenheit unit of measurement (°C or °F), see “Set General System Settings” on page 120.

Power Schedule



NOTE Power schedules can be set by an Administrator with Read/Write/Control only.

Define a Power Schedule

1. Access the Web interface and log in.
2. Under Power Management, select Outlets. The Outlets page displays.
3. Select an outlet and click the outlet name. The Outlet Settings dialog displays.
4. Check the Power Schedule checkbox.

5. Add an action in the first action block by selecting either **On**, **Off**, or **Reboot** from the drop-down list.
 - **None:** The actions in this schedule are not executed. This is the default upon opening this dialog. (You can use this setting to hold the settings for future activation.)
 - **Off:** Select this value to switch off the current outlet according to the corresponding schedule you specify.
 - **On:** Select this value to switch on the current outlet according to the corresponding schedule you specify.
 - **Reboot:** Select this value to switch off and then switch back on the current outlet according to the corresponding schedule setting. The delay between the Off and the On can be set on the Outlet Settings dialog using the **Power Reboot Period** field (see Step 9 on page 111). With this setting, additional actions scheduled by the Further Actions selections are disabled.
6. Set the time schedule for this action by selecting a time from the “at:” drop-down list.
7. Set the date schedule for this action by selecting a date from the “Date of Action” selection calendar.

**NOTE**

“Date of Action” fields are only available when the “Recurrent” checkbox is unchecked. This field specifies the date when the action will be executed, but only once. If you want the action to be scheduled to repeat, see Step 11.

8. **Optional.** You can add additional scheduled actions. For example, suppose your first action is On. You can pair it with a subsequent Off action. The schedule for this second action is set by selecting **Off** from the Further Action drop-down list and setting values in the date and time fields. By default, this second action is set to “None,” meaning nothing more will happen.
 - **None:** The actions in this schedule are not executed at the specified time. This is the default if the Action is set to Off or On.
 - **Off:** Select this value to switch off the current outlet according to the corresponding schedule setting.
9. Set the schedule for this action by selecting a date and time from the drop lists for the “at:” and Date of Action” field.

**NOTE**

This date and time must occur after the date and time set for the first action.

10. Click **Save**.
11. Do you want to make the Power Schedule recurrent, so that specified schedules are executed multiple times?
 - If yes, go to Step 12.
 - If no, this procedure is completed.

**NOTE**

When a power schedule is recurrent, you set the schedule to repeat on specified days. To set any schedule, including recurrence, the Action or Further action cannot be set to “None.”

12. Check the Recurrent checkbox.
13. In the active days field, select which day or days to be affected by this action. When settings are saved, the “Date of Action” value is automatically set to the date of the first occurrence of the action.
14. Click **Save**.

Active Alarms



NOTE When the Active Alarms menu item in the menu bar list is red and displays an exclamation mark icon, an alarm is active.

Review Active Alarms

1. Access the Web interface and log in.
 2. Under Power Management, select Active Alarms. The Active Alarms page displays.
 3. Ensure the ePDU operation button in the upper left corner is not collapsed. If so, expand it to see the list of alarms.
 4. Review the alarm detection date/time, description, the threshold setting, and the value reading that triggered the alarm.
-



NOTE 1 The term “active alarms” indicates that the alarm is currently set. When an alarm is no longer active, it is removed from this page.

NOTE 2 The format of the date is set on the System Date & Time submenu (see “Date & Time” on page 122).

Logs

Clear the Event Log

1. Access the Web interface and log in.
 2. Under Logs & Notifications, select Logs. The Logs page displays.
 3. Click **Clear**.
-



NOTE Only a user with read-write access can clear the log. Click the arrow beside Type to sort the order of the columns, to apply filters to see the logs for a specific data type, or to sort all data in ascending or descending order.

Download the Event Log as a Comma Separated Value File

1. Access the Web interface and log in.
 2. Under Logs & Notifications, select Logs. The Logs page displays.
 3. Click **Save to File**. The File Download dialog displays.
 4. Click **Save**. The Save As window displays.
 5. From the **Save in** drop-down list, specify where the file should be downloaded.
 6. Either accept the default file name (logevent.csv) or enter a new file name.
 7. Click **Save**.
-



NOTE To import a CSV file in Excel, select the UTF-8 format.

NOTE For daisy-chained ePDUs:



- ePDU type 00 indicates the Host ePDU [0] logs.
 - ePDU type 01 indicates the Device ePDU [1] logs.
 - ePDU type 02 indicates the Device ePDU [2] logs.
 - ePDU type 03 indicates the Device ePDU [3] logs.
 - ePDU type 04 indicates the Device ePDU [4] logs.
 - ePDU type 05 indicates the Device ePDU [5] logs.
 - ePDU type 06 indicates the Device ePDU [6] logs.
 - ePDU type 07 indicates the Device ePDU [7] logs.
-

Trap Notification

Define the Trap Receivers

1. Access the Web interface and log in.
2. Under Logs & Notifications, select Trap Notification. The Trap Notification page displays.
3. Click a linked Trap Receiver in the Name column to select the trap receiver to define.
4. Type the name to identify the trap receiver. This value is not used to send traps.
5. Choose one of the following protocols:
 - **Disable**: The trap receiver is disabled. (No trap is sent to this user and the **Test** button is deactivated.)
 - **SNMP v1**: Traps are sent over SNMPv1 protocol. (It must be compliant with the SNMP version defined in "Enable/Disable the SNMP Agent" on page 126.)
 - **SNMP v3**: Traps are sent over SNMPv3 protocol. (It must be compliant with the SNMP version defined in "Enable/Disable the SNMP Agent" on page 126.)
6. Type the trap receiver IPv4 / IPv6 address or its host name.
7. Type the trap community (public or private).
8. From the On Event drop down list, select one of the following trap sources:
 - **Disable**: The trap receiver is disabled and the **Test** button is deactivated.
 - **All Alarms**: The trap receiver is enabled.
9. Click **Save**. If desired, test the configuration (see "Test Trap").
10. Click **Test**. (See the "Test Trap" section that follows for more information).

Test Trap**NOTE**

To receive the test trap #53, the trap receiver must be configured with a protocol compliant with the one defined as the trap source (see "Enable/Disable the SNMP Agent" on page 126).

This action consists of sending a test trap (#53) to all configured and enabled trap receivers. To achieve this action, the following requirements must be met:

- The ePDU Network Management and Control (eNMC) module is running in Normal Operation mode.
- The ePDU Network Management and Control (eNMC) module is connected to the Local Area Network (LAN).
- The ePDU Network Management and Control (eNMC) module owns a valid IP address.
- The SNMP must be enabled: SNMPv1, SNMPv3, or SNMPv1&v3.

The target trap receiver configuration requires a valid IP address and the trap receiver protocol must match the configured SNMP version.

**NOTE**

See "Enable/Disable the SNMP Agent" on page 126.

Syslog**Retrieve or Modify Syslog Data**

1. Access the Web interface and log in.
2. Under Logs & Notifications, select Syslog. The Syslog Server page displays.
3. Review to the Syslog status, the port number, and the protocol for the specified Syslog server.
4. To enable or disable a server, click the check box beside the Syslog server name and click the **Enable** or **Disable** button.
5. To modify the settings for a server, click the Syslog name. The Syslog Server Settings dialog displays.
6. In the Syslog Server Settings dialog, enable or disable the selected server from the Enable Server drop-down list. You can also change the following:
 - port number and the protocol selection to either UDP or TCP from the Protocol drop-down list
 - message transfer method according to:
 - 5424: Syslog Protocol IETF
 - 5425: TLS
 - 5426: Transfer over UDP
 - 6587: Transfer over TCP
 - 3167: Syslog protocol IETF (obsolete)
 - facility code used for all messages from 1 to 23
 - use of unicode byte order mask (BOM) according to RFC 5424
7. When you finish modifying Syslog server settings, click **Save** or **Cancel**.
8. (Optional). Click **Test** to test the configuration.

Access Accounts

Configure the SuperUser

1. Access the Web interface and log in.
2. Under Settings, select Access Accounts. The Access Accounts page displays.
3. In the Admin Access panel, perform the following:
 - Type the SuperUser login.
 - Type the SuperUser password.
 - Type the SuperUser password again.
4. Click **Save**.

Configure the E-mail Notification Settings



NOTE 1 By default, an e-mail address is attached to each account.

NOTE 2 Any user can change his own e-mail address.

1. Access the Web interface and log in.
2. Under Settings, select Access Accounts. The Access Accounts page displays.
3. In the Admin Access panel, click the e-mail address link.
4. The e-mail recipient address displays. If needed, change the address.
5. If needed, type the descriptive text to identify the e-mail receiver.
6. Enable or disable the e-mail receiver in the status drop-down list.
7. Check the Attached Files check box to attach the event log file to the e-mail sent to this receiver, or uncheck the box to send the e-mail without the event log file.
8. Select the date of the next report using the date picker or manually enter the date in mm/dd/yyyy format.
9. Set the frequency of the report if this recipient should receive regular reports.
10. Set the time of delivery using the drop-down list.
11. From the On Event drop down list, select one of the following:
 - **Disable**: E-mail delivery is disabled and the **Test** button is deactivated.
 - **All Alarms**: E-mail is enabled and the **Test** button is activated.
12. Click **Test** to send a test e-mail.
13. Otherwise, click **Save** or **Cancel**.

Configure the LCD Password



NOTE 1 Only an administrator can activate, deactivate, or modify the LCD password.

NOTE 2 There can only be one LCD password on the ePDU.

1. Access the Web interface and log in.
2. Under Settings, select Access Accounts. The Access Accounts page displays.

3. In the LCD Access panel, perform the following:

- Activate the feature to change the password.
- Type the LCD password.
- Type the LCD password again.

4. Click **Save**.

Configure Local User Access

NOTE 1 Only an administrator can create or modify a user account.



NOTE 2 Local users can use this user name and password for authentication if the authentication mode selected in the Network Security Global submenu is Local (see “Set Authentication Mode” on page 130).

NOTE 3 The User name is used for authentication. It must be unique. If there is a name conflict when you are creating a new account, a warning message displays.

1. Access the Web interface and log in.
2. Under Settings, select Access Accounts. The Access Accounts page displays.
3. In the Multi-User Access panel, select **Add a local user** from the Add drop down list. The Users Settings dialog displays.
4. Perform the following:
 - Type the user’s login user name to replace the default name.
 - Type the user’s password (minimum of five characters).
 - Type the user’s password again.
5. Choose one of the following profile characteristics:
 - **Admin:** This user has administrator privileges and controls the access of other users to the Web interface. The Administrator can restart the communications module, but cannot perform a firmware upgrade.
 - **ePDU User:** This user has access to the ePDU and either read only or restricted read-write privileges.
6. Choose one of the following security levels:
 - **No Access:** The user is not allowed to access the Web interface.
 - **Read-Only:** The user can access the Web interface, view the measures, and view the thresholds of the outlets and groups. This user is not allowed to change any settings or perform actions.
 - **Read/Write:** The user can access the Web interface, view the measures, and is allowed to change settings.
7. To configure an e-mail address for this account, click the link of the e-mail address corresponding to this user. See “Configure the E-mail Notification Settings” for more information.
8. Click **Save**.
9. To enable an e-mail address for this account, click the link on the e-mail address under the e-mail Address column.

Configure Remote Group Access



NOTE 1 A remote account is an account that will be created on the communications module in order to be attached to LDAP users so they can use the ePDU. The account should already exist on the LDAP database.

NOTE 2 These LDAP users will use their LDAP login/password for authentication on the module.

1. Under Settings, select Access Accounts. The Access Accounts page displays.
2. In the Multi-User Access panel, select **Add a remote group** from the Add drop down list. The Remote Group Settings dialog displays.
3. Type the remote group login user name to replace the default name.



IMPORTANT

This login user name must match the group name that the user has in the LDAP database.

4. Choose one of the following profile characteristics:
 - **Admin:** This remote group has administrator privileges and controls the access of other users to the Web interface.
 - **ePDU User:** The administrator assigns this remote group either read only or read-write privileges to this user.
5. Choose one of the following security levels:
 - **No Access:** The user is not allowed to access the Web interface.
 - **Read-Only:** The remote group can access the Web interface, view the measures, and view the thresholds of the outlets and groups. This user is not allowed to change any settings or perform actions.
 - **Read/Write:** The remote group can access the Web interface, view the measures, and is allowed to change settings.
6. To configure an e-mail address for this account, click the link of the e-mail address corresponding to this user. See "Configure the E-mail Notification Settings" for more information.
7. Click **Save**.
8. To enable an e-mail address for this account, click the link on the e-mail address under the e-mail Address column.

System

NOTE The Web interface will not be available as follows:



- during firmware upgrades using the **Upgrade network management card** button
- during a communications module restart using the **Restart network management card** button
- during restoration to factory defaults using the **Restore factory to default settings** button

Set General System Settings



NOTE Refresh the Web pages (press F5) to see changes to the general system settings.

1. Access the Web interface and log in.
2. Under Settings, select System. The System Settings page displays.
3. In the General panel, type the Device Administrator Contact Name and the Device location in the text boxes.
4. To change the language, select a language from the drop down list (see Figure 94).

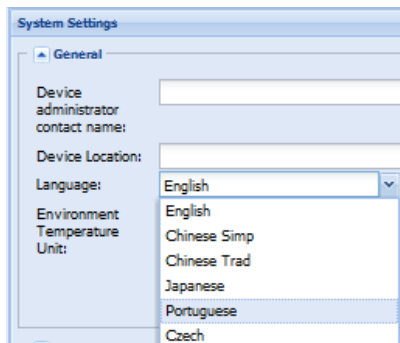

Figure 94. Change Language on System Settings Page

5. Select °C or °F in the Temperature drop-down list to change the temperature scale (Celsius or Fahrenheit unit of measurement).
6. Click **Save**.

Enable/Disable Firmware Upgrade

1. Access the Web interface and log in.
2. Under Settings, select System. The System Settings page displays.
3. In the Network Management Card panel, choose whether the firmware upgrade functionality can be used:
 - **Enabled:** Check the check box to use the firmware upgrade functionality (default).
 - **Disabled:** Uncheck the check box to disable the firmware upgrade functionality.
4. To save your changes, click **Yes** in response to the message prompt.

Configure ePDU Network Management and Control Module

1. Access the Web interface and log in.
2. Under Settings, select System. The System Settings page displays.
3. In the Network Management Card Configuration panel, choose whether the IP setting and/or Daisy Chain settings should remain unchanged after a default factory reset of the eNMC module.
 - **Enabled:** Check the check box beside the Keep IP parameters when “Restore Factory Default Settings” to retain IP settings at their current values after restoration. Check the check box beside the Keep Daisy Chain parameters when “Restore Factory Default Settings” to retain IP settings at their current values after restoration.
 - **Disabled:** Uncheck the check box to reset IP settings (or Daisy Chain settings) to default values (default).
4. To select and store an eNMC module configuration file to be used during an upgrade, use **Browse** to review and select the configuration file.



NOTE When uploading a file, you cannot write the file path in the text field. You must select the file from the file explorer window that displays when you click **Browse**.

-
5. Click either **Upload** or **Download Configuration** and a message is provided to tell you if the file uploaded successfully or failed to upload:
 - **Upload:** Gets the list of the ePDU XML parameters from a file selected by the browser and sends it to the ePDU. When the upload completes, a pop-up confirmation message displays:
The file has been successfully uploaded.
You must reboot your Network Management Card for changes to take effect.
Note: This will NOT restart the PDU or change the power status of the outlets.



NOTE Changes to network parameters require a restart, but all other setting changes will take effect immediately.

-
- **Download Configuration:** Stores a list of the ePDU XML parameters in a file selected by the browser.
6. To restore the eNMC module to factory defaults, click **Restore Factory to default settings**. A pop-up confirmation message displays:
Are you sure you want to restore the factory default settings of the Network Management Card?
Note: This will NOT restart the ePDU or change the power status of the outlets.

Perform Firmware Upgrade



NOTE A firmware upgrade can only be performed by a SuperUser. This upgrades the firmware and the Web page. The Web interface will not be available during the upgrade.

-
1. Access the Web interface and log in.
 2. Under Settings, select System. The System Settings page displays.
 3. In the Network Management Card panel, ensure the firmware upgrade functionality is enabled and that the upgrade file has been downloaded.

4. To upgrade the communications module, click **Upgrade network management card**. The upgrade is launched immediately.
5. Click **Restart network management card**.
6. When the upload of the image file completes, the following message displays:

```
Your file was correctly uploaded.
Please wait about three minutes while the image writes to your flash device,
then click the browser refresh button.
Click OK to restart the card and begin the upgrade of the firmware.
```

ePDU Configuration

1. Access the Web interface and log in.
2. Under Settings, select System. The System Settings page displays.
3. Ensure that the Device Administrator Contact Name and the Device location have been typed in the text boxes.
4. To select and store an eNMC module configuration file to be used during an upgrade, use **Browse** to review and select the configuration file.



NOTE When uploading a file, you cannot write the file path in the text field. You must select the file from the file explorer window that displays when you click **Browse**.

5. Click either **Upload** or **Download Configuration** and a message is provided to tell you if the file uploaded successfully or failed to upload:
 - **Upload:** Gets the list of the ePDU XML parameters from a file selected by the browser and sends it to the ePDU.
 - **Download Configuration:** Stores a list of the ePDU XML parameters in a file selected by the browser.



NOTE 1 The file to upload must be a file compatible with the hardware of the ePDU. If not, the upload does not process due to an incompatibility error.

NOTE 2 You do not need to restart the card after a successful upload.

Date & Time

Manually Configure the Date and Time

1. Access the Web interface and log in.
2. Under Settings, select Date & Time. The Date & Time page displays.
3. In the Global Settings panel, choose the date format from the drop-down list.
4. Click **Save**.
5. Click the **Set manually** radio button.
6. Type the date according to the format defined by Date Format, or select the date using the date picker.
7. Type the time or select a time from the drop-down list. The time format is *hh:mm:ss*, where *hh* = hours, *mm* = minutes, *ss* = second.
8. Click **Save**.



NOTE Changing the date to a future date and then reverting the date to the current date may affect the order of the display in the logs.

Automatically Configure the Date and Time

1. Access the Web interface and log in.
2. Under Settings, select Date & Time. The Date & Time page displays.
3. In the Global Settings panel, choose the date format.
4. Click **Save**.
5. In the Global Settings panel, click the **Synchronize with NTP Server** radio button
6. Type the Time Server IPv4 / IPv6 address or host name.
7. Choose the time zone from the drop-down list.
8. Choose one of the following DTS (Daylight Saving Time) options:
 - **No Daylight Saving**
 - **European DST**
 - **American DST**
9. Click **Save**.



NOTE

The ePDU Network Management and Control (eNMC) module retrieves the date and time from the configured NTP server every hour.

TCP/IP



NOTE

The Web interface will not be available during a communications module restart using the **Restart network management card** button.

Configure the Ethernet Link Speed and Duplex Mode

NOTE

By default, the Ethernet link speed and duplex mode is configured on “auto-negotiation” which means the eNMC module adapts its Ethernet speed and duplex mode to the network on which it is connected. However, it is possible to force the following modes:



- Auto-negotiation
- 100 Mbps Full Duplex
- 100 Mbps Half Duplex
- 10 Mbps Full Duplex
- 10 Mbps Half Duplex

1. Access the Web interface and log in.
2. Under Network, select TCP/IP. The TCP/IP page displays.

3. In the Ethernet panel, choose one of the following link speed and duplex modes from the drop-down list:
 - Auto-negotiation
 - 100 Mbps Full Duplex
 - 10 Mbps Half Duplex
 - 10 Mbps Full Duplex
 - 10 Mbps Half Duplex
4. Click **Save**.
5. Open the System page. In the Network Management Card panel, click **Restart network management card** to restart the ePDU Network Management and Control (eNMC) module. A pop-up confirmation message displays:

Are you sure you want to restart the Network Management Card?

Note: This will NOT restart the ePDU or change the power status of the outlets.

Configure the IPv4 Settings

1. Access the Web interface and log in.
2. Under Network, select TCP/IP. The TCP/IP page displays.
3. In the IPv4 panel, select the manner by which IPv4 settings are configured from the BootP/DHCP drop-down list:
 - **Enabled**. The IPv4 settings are configured by the DHCP server. If DHCP is enabled, go to Step 5.
 - **Disabled**. The IPv4 settings are manually configured by the user. If DHCP is disabled, perform the following:
 - Type the IPv4 address.
 - Type the IPv4 subnet mask.
 - Type the IPv4 address of the gateway (if any).
 - Type the ePDU host name (used for DNS resolution).
 - Type the ePDU domain name (used for DNS resolution)
4. Click **Save**.
5. Open the System page. In the Network Management Card panel, click **Restart network management card** to restart the ePDU Network Management and Control (eNMC) module. A pop-up confirmation message displays:

Are you sure you want to restart the Network Management Card?

Note: This will NOT restart the ePDU or change the power status of the outlets.

Configure the IPv6 Settings



NOTE By default, the IPv6 interface is disabled. You can enable it from the Web interface or the Serial interface.

1. Access the Web interface and log in.
2. Under Network, select TCP/IP. The TCP/IP page displays.
3. In the IPv6 panel, enable the IPv6 interface by checking the **IPv6 Enabled** check box.

4. Select one of the following configuration methods for IPv6 settings
 - For manual configuration, uncheck the **IPv6 Address Auto Configuration Enabled** check box. Continue to Step 5.
 - For auto configuration, check the **IPv6 Address Auto Configuration Enabled** check box. Continue to Step 10.

NOTE 1 For manual configuration, provide the IPv6 global address with its prefix length and the IPv6 address of the gateway (if any).



NOTE 2 For auto-configuration, the global IPv6 addresses and prefix lengths are automatically configured by the network (an IPv6 router is required). The gateway IPv6 address is defined by the user.

NOTE 3 Regardless of the configuration you choose, the local IPv6 address is auto-generated by the eNMC module.

5. Type the local IPv6 address.
6. Type the prefix length for the global IPv6 address.
7. Type the IPv6 gateway address (if any).
8. Type the second IPv6 address and prefix.
9. Click **Save**.
10. Open the System page. In the Network Management Card panel, click **Restart network management card** to restart the eNMC module. A pop-up confirmation message displays:
Are you sure you want to restart the Network Management Card?
Note: This will NOT restart the ePDU or change the power status of the outlets.

Configure the DNS

When the IPv4 address is automatically obtained by DHCP, the DNS server addresses (primary and secondary) are provided by the DHCP server.

You can define DNS IPv4/IPv6 addresses from the Web and Serial interfaces. However, this configuration is overwritten when the ePDU Network Management and Control (eNMC) module restarts and the IPv4 address is obtained from a DHCP server that provides DNS addresses.

1. Access the Web interface and log in.
2. Under Network, select TCP/IP. The TCP/IP page displays.
3. In the DNS panel, type the primary DNS server's IPv4 or IPv6 address.
4. Type the secondary DNS server's IPv4 or IPv6 address (if any).
5. Click **Save**.

Configure the SMTP

1. Access the Web interface and log in.
2. Under Network, select TCP/IP. The TCP/IP page displays
3. In the SMTP panel, type the SMTP server IPv4 / IPv6 address or host name.
4. If not already provided, type the SMTP port.

5. If your SMTP server requires authentication, perform the following:
 - Check the SMTP Server Authentication check box.
 - Type the login.
 - Type the password.
 - If not already provided, type the sender address.
6. Click **Save**.

SNMP

Enable/Disable the SNMP Agent

1. Access the Web interface and log in.
2. Under Network, select SNMP. The SNMP Settings page displays.
3. Choose one of the following SNMP versions:
 - **Disabled**: the agent is disabled; the MIB cannot be read and no traps are sent.
 - **SNMPv1**: only SNMPv1 users and SNMPv1 traps are supported.
 - **SNMPv3**: only SNMPv3 users and SNMPv3 traps are supported.
 - **SNMPv1 & v3**: both SNMPv1 and SNMPv3 users and traps are supported.
4. Type the SNMP Port number and the SNMP Trap Port number in the entry boxes.
5. Click **Save**.

Define SNMPv1 Users

1. Access the Web interface and log in.
2. Under Network, select SNMP. The SNMP Settings page displays.
3. Ensure that SNMPv1 is selected in the SNMP Version field.
4. In the SNMP V1 panel, in the Community column, select the SNMPv1 user to configure. The Community Settings dialog displays.
5. Choose one of the following access rights for the selected SNMPv1 user:
 - **No Access**: The user is not allowed to access the Web interface.
 - **Read-Only**: the SNMPv1 user can only get the MIB objects.
 - **Read-Write**: the SNMPv1 user can get and set the MIB objects.
6. Click **Save**. Otherwise, click **Cancel** to return to the SNMP Settings page.

Define SNMPv3 User-based Security Model Users

1. Access the Web interface and log in.
2. Under Network, select SNMP. The SNMP Settings page displays.
3. Ensure that SNMPv1 is selected in In the SNMP Version field.
4. In the SNMP V3 panel, in the Users column, select the SNMPv3 user to configure. The SNMP User Settings dialog displays.

5. Choose one of the following access rights for the SNMPv3 user:
 - **No Access:** the SNMPv3 user is disabled with no access to the MIB objects.
 - **Read-Only:** the SNMPv3 user can only get the MIB objects.
 - **Read-Write:** the SNMPv3 user can get and set the MIB objects.
6. Choose one of the following security levels to be applied to the SNMPv3 user:
 - **Not Set:** the SNMPv3 user is not configured and therefore disabled.
 - **Auth Priv:** an authentication password and a privacy key are required to access the MIB objects.
 - **Auth No Priv:** an authentication password but no privacy key are required to access the MIB objects.
 - **No Auth No Priv:** no authentication password or privacy key are required to access the MIB objects.
7. Type the authentication password (if required by security level), with 8 to 24 characters allowed.
8. Type the privacy key (if required by security level), with 8 to 24 characters allowed.
9. Click **Save**. Otherwise, click **Cancel** to return to the SNMP Settings page.

Access Eaton ePDU MIB Objects (Privileged Access Only)

1. Access the Web interface and log in.
2. Under Network, select SNMP. The SNMP Settings page displays.
3. Click **Link to the ePDU MIB**.

Energy Wise

Enable Energy Wise

1. Access the Web interface and log in.
2. Under Network, select **Energy Wise**. The Energy Wise page displays.
3. In the Configuration panel, ensure that the **Enable** check box is checked and that the associated SDK Version number displays. (The SDK version is not editable.)
4. Type the Domain name (maximum 63 characters).
5. For Security, select **Enabled or Disabled**.
6. For Secret, type the secret key (maximum 63 characters).
7. For Threshold Level, type a threshold number (minimum value 0, maximum value 10).
8. For the Remote Port and Listen Port value, type a port number (minimum value 1, maximum value 65535).
9. Click **Save**.

Disable Energy Wise

1. Access the Web interface and log in.
2. Under Network, select **Energy Wise**. The Energy Wise page displays.
3. In the Configuration panel, ensure that the **Disabled** check box is checked. (When **Disable** is selected, all other fields in the Configuration panel are also disabled.)
4. Click **Save**.

Start/Stop Energy Wise Commands

1. Access the Web interface and log in.
2. Under Network, select **Energy Wise**. The Energy Wise page displays.
3. The current Energy Wise state value displays in the Status field. Valid states are:
 - Unknown
 - Not Initialized
 - Stopped
 - Stopping
 - Starting
 - Started
 - Down
 - Initializing
 - Up
 - Active
 - Requested Shutdown
4. For Command, select one of the following from the drop-down list:
 - Start
 - Graceful Stop
 - Off-State Cache Stop
 - Restart
5. Click **Save**.

Security**Enable/Disable SSL Encryption**

Up to four ePDUs may be daisy-chained when using the SSL with 2048 byte encryption key size.

1. Access the Web interface and log in.
2. Under Network and Security, select Global. The Security page displays.
3. In the Ports Settings panel, ensure that the **HTTP Enable** check box is checked and that the associated HTTP Port number displays.
4. Check the **Force SSL** check box to enable SSL encryption, or uncheck the box to disable it. If enabled, the HTTPS Port entry box is active. Type the port number.
5. Click **Save**.
6. Open the System submenu in the Settings menu. In the Network Management Card panel, click **Restart network management card** to restart the ePDU Network Management and Control (eNMC) module.

NOTE 1 With SSL encryption, the Web interface is accessible from **https://<IPv4 address>** and the **https://[IPv6 address]**, or both, according to the IP configuration.



NOTE 2 When **Force SSL** is selected, the Web page is only available through HTTPS. If you enter the IP address through HTTP, it will be automatically redirected to HTTPS and you will receive the following message and a new URL link:
 The Network Management Card is protected by SSL encryption.
 Please use the following address(es) to connect to the Network Management Card. <https://166.99.224.82>

Enable/Disable the Telnet Interface

NOTE 1 Selecting a console type on the Security page makes the corresponding port entry box active.



NOTE 2 Not selecting a console type makes the corresponding port entry box inactive and grayed-out.

1. Access the Web interface and log in.
2. Under Network and Security, select Global. The Security page displays.
3. In the Ports Settings panel, select **Telnet** from the Console drop-down list to enable the Telnet interface, or select **Disabled** to disable it.
4. If enabled, the Telnet Port entry box is active. Type the port number.
5. Click **Save**.
6. Open the System submenu in the Settings menu. In the Network Management Card panel, click **Restart network management card** to restart the ePDU Network Management and Control (eNMC) module.

Enable/Disable the SSH Interface

1. Access the Web interface and log in.
2. Under Network and Security, select Global. The Security page displays.
3. In the Ports Settings panel, select **SSH** from the Console drop-down list to enable the SSH interface, or select **Disabled** to disable it.
4. If enabled, the SSH Port entry box is active. Type the port number.
5. Click **Save**.
6. Open the System submenu in the Settings menu. In the Network Management Card panel, click **Restart network management card** to restart the ePDU Network Management and Control (eNMC) module.

Enable/Disable FTP

1. Access the Web interface and log in.
2. Under Network and Security, select **Global**. The Security page displays.
3. In the Ports Settings panel, select one of the following from the drop-down list:
 - FTP enable
 - Force FTPS (“Explicit FTPS” is used by default)
4. Check the **FTP Enable** check box to enable FTP, or uncheck the box to disable it.
5. Click **Save**.
6. Open the System submenu in the Settings menu. In the Network Management Card panel, click **Restart network management card** to restart the eNMC module.

Set Authentication Mode

1. Access the Web interface and log in.
2. Under Network and Security, select Global. The Security page displays.
3. In the Authentication Mode panel, select a value from the External Authentication drop-down list:
 - **None:** This disables external authentication. The Preference Order field is automatically checked to the **Local First, then External** value.
 - **Radius:** This enables RADIUS. If LDAP or RADIUS are enabled, you must set a preference order in the Preference Order drop-down list:
 - **External First, then Local**
 - **Local First, then External**
 - **External only**
 - **LDAP:** This enables LDAP. If enabled, you must set a preference order in the Preference Order drop-down list:
 - **External First, then Local**
 - **Local First, then External**
 - **External only**
4. Click **Save**.
5. Open the System submenu in the Settings menu. In the Network Management Card panel, click **Restart network management card** to restart the eNMC module.

Set LDAP Search Configuration

NOTE Each selection combination requires a different set of entries. Only applicable fields are active. Fields that do not apply to your selection are inactive.



- Active fields are white and the inactive fields are blue shaded.
 - When you click your cursor in inactive fields, nothing happens.
 - You can type in active fields.
-

1. Access the Web interface and log in.
2. Under Network and Security, select LDAP. The LDAP page displays.

3. Select the LDAP Server Type, User Search Bind, and Authorization Mode values from the drop-down list:
 - **LDAP Server Type:** Allows you to select a configuration.
 - **Active Directory:** Allows to configure a typical AD configuration. Some fields are read-only (User Object and User Attribute are disabled).
 - **Other:** All fields are editable.
 - **User Search Bind:** Defines if a special user for the LDAP searches must be used.
 - **Anonymous Search:** Search bind uses an anonymous way (Search User and Password are disabled)
 - **User bind Search:** Uses an LDAP user.
 - **Search User:** DN (if Bind Type = simple) or the username (if Bind Type = MD5) of the LDAP user allowed to search in the LDAP dictionary.
 - **Password:** Password of the Search User.
 - **User Base DN:** Entry of the LDAP dictionary where to start the user search.
 - **User Object:** Object class of the LDAP users.
 - **User Attribute:** Login identifier.
 - **Authorization Mode:** Choose authorization by user attribute or by group.
 - **By User attribute:** Stores the group name in the user attribute (Group Name Attribute).
 - **By Group:** Stores the group name in the group LDAP object (UPS Group Base DN).
 - **PDU Group Base DN:** LDAP dictionary entry from which the group search starts.
 - **Group Name Attribute:** LDAP attribute that stores the group name.
 - **User Name Attribute:** LDAP attribute that stores the users names linked to this group.
4. The resulting required field entries are active and highlighted. Type the associated values in the active entry boxes.
5. Click **Save**.

Authenticate LDAP Remote User

To test the login and password and authenticate an LDAP remote user:

1. Access the Web interface and log in.
2. Under Network and Security, select LDAP. The LDAP page displays.
3. In the LDAP Authentication Test panel, select the following:
 - **Login:** The login of the remote user.
 - **Password:** The password of the remote user.
4. Click **Test**. An authentication test is launched and a message displays on the LDAP Authentication Test panel to indicate if the authentication was successful or unsuccessful.

Table 9 provides authentication error messages and descriptions of possible causes.

Table 9. Authentication Error Messages and Possible Causes

Error Message	Description
User Not Found	<ul style="list-style-type: none"> ▫ Bad value in the User Object field. The usual value for AD is user. ▫ Bad value in the User Attribute field. The usual value for AD is sAMAccountName. ▫ Although the DN set in the User Base DN field exists in the LDAP Server, the login input is not found under the LDAP tree of this object. ▫ The login input does not exist in the LDAP Server.
Search Bind Failed	<ul style="list-style-type: none"> ▫ The User Search Bind field is set to Anonymous, but this mode is not supported by the LDAP Server. ▫ The User Search Bind field is set to User Bind Search, but the Password is empty while it is required by the LDAP server.
Search User Invalid Credential	<ol style="list-style-type: none"> 1. Bad value in the Password field of the Search User. 2. Bad value in the Search User field: <ul style="list-style-type: none"> ▫ In SASL MD5 mode: <ul style="list-style-type: none"> A DN is used in the Search User field instead of a name. The DNS does not provide the reverse resolution of the LDAP server IP. ▫ In simple mode: <ul style="list-style-type: none"> Usually, a DN must be used in the Search User field. ▫ Regardless of the mode: <ul style="list-style-type: none"> The Search User input did not match any existing object in the LDAP database.
Root for User Base DN is incorrect	<ul style="list-style-type: none"> ▫ The root part of the User Base DN field is incorrect.
Relative Distinguished Name for User Base DN is incorrect	<ul style="list-style-type: none"> ▫ The root part of the User Base DN field is correct, but the remaining part does not exist in the LDAP server.
User Invalid Credential	<ul style="list-style-type: none"> ▫ The login password is incorrect.
LDAP Search Group Not Found	<ul style="list-style-type: none"> ▫ No remote group has been set in the Access Accounts page. ▫ No relationship has been found between the PDU remote groups and the LDAP groups. ▫ Although the DN set in the PDU Group Base DN field exists in the LDAP Server, no PDU remote groups have been found under the LDAP tree of this object. ▫ Bad value in the Group Name Attribute field (configuration Other). ▫ Bad value in the User Name Attribute field (configuration Other).
Root for Group Base DN is incorrect	<ul style="list-style-type: none"> ▫ The root part of the PDU Group Base DN field is incorrect.
Relative Distinguished Name for Group Base DN is incorrect	<ul style="list-style-type: none"> ▫ The root part of the PDU Group Base DN field is correct, but the remaining part does not exist in the LDAP server.
LDAP Server Unavailable	<ul style="list-style-type: none"> ▫ Bad LDAP server IP address. ▫ Bad LDAP server port. ▫ Bad LDAP server name. ▫ In case of LDAPS/Start TLS Encryption method: <ul style="list-style-type: none"> The LDAP server is not configured to use SSL. The PDU Authority Certificate is required by the LDAP server but it has not been added in the certificate store of the LDAP server as Trusted Certification Authority. If the Activate AC Certificate field of the LDAP Server Global Parameters panel is checked, the LDAP Server Authority Certificate uploaded in the PDU is not the correct.

Set LDAP Server Global Parameters

1. Access the Web interface and log in.
2. Under Network and Security, select LDAP. The LDAP page displays.
3. In the LDAP Server Global Parameters panel, select the following:
 - **Encryption Method:** The Encryption method defines if an SSL connection is used between the ePDU and the LDAP server when the LDAP requests are sent during the ePDU user authentication process. From the drop-down list, select one of the following:
 - **None:** (No SSL connection) The data is sent without encryption. The standard port number is 389 (the port for no encryption). It can be set or modified from the LDAP Server Settings dialog.
 - **LDAPS:** (With SSL Connection) This selection uses an LDAP-over-SSL connection. The standard port number is 636. It can be set or modified from the LDAP Server Settings dialog
 - **Start TLS:** (With SSL Connection) Use the "start TLS" extension (RFC 2830). The standard port number is 389 (the same port that for no encryption). It can be set or modify from the LDAP Server Settings dialog.
 - **Bind Type:** The bind operation uses the LDAP user credentials to identify the LDAP authentication connection between the ePDU and the LDAP server. From the drop-down list, select one of the following:
 - **Simple:** The user credentials are sent without encryption. However, if an SSL connection is used, the credentials are encapsulated in an SSL-encrypted connection.
 - **SASL Digest MD5:** Using MD5, a hash algorithm is used to encrypt the user credentials.
4. To upload your AC Certificate, select **Browse**. Highlight the selected file and click **Open**.



IMPORTANT

The AC Certificate is the AC Certificate of the LDAP server, not the AC Certificate of the ePDU. The certificate format is a Base64 encoded DER certificate, enclosed between the "-----BEGIN CERTIFICATE-----" and "-----END CERTIFICATE-----" tag. In order to configure your LDAP server for SSL, you need the AC certificate of the ePDU certificate.



NOTE

When uploading a file, you cannot write the file path in the text field. You must select the file from the file explorer window that displays when you click **Browse**.

5. Click **Upload**.
6. Click **Save**.

Modify LDAP Server Settings

1. Access the Web interface and log in.
2. Under Network and Security, select LDAP. The LDAP page displays.
3. In the LDAP Server panel, click a linked host name. The LDAP Server Settings dialog displays.
4. In the Enable Server drop-down list, select **Enable** or **Disable** to enable or disable the selected LDAP server or servers.
5. If enabled, you can choose to change the server name, the port number, and the number of seconds to time out in the Server, Port, and Time Out (sec) entry boxes.
6. Click **Save**. Otherwise, click **Cancel** to return to the LDAP page.

Add RADIUS Server

Authorization configuration must be done in the radius server to add the ePDU remote group defined in the Remote Group Access ePDU setting.

The authorization is based on the information sent by the server through the following RADIUS attribute:

- Vendor Specific ID: 534
- Vendor Specific Attribute ID: 29, format string

The authorization strings sent by the server from the vendor-specific attributes (VSA) are compared with the remote groups configured in the ePDU. If a remote group is found, the profile user linked to the remote group is set to the remote user (in case of authentication success). If no group is found, the access is rejected by the ePDU.

This attribute must be added in the RADIUS server configuration and must be sent for each remote user allowed to access to the ePDU.

To add a RADIUS server:

1. Access the Web interface and log in.
2. Under Network and Security, select RADIUS. The RADIUS page displays.
3. In the RADIUS Server panel, select the following:
 - **Authentication Protocol:** Select an authentication method from the drop down list, either Password Authentication Protocol (PAP) or Challenge-Handshake Authentication Protocol (CHAP).
4. Check the **Add** check box.
5. In the RADIUS Settings panel, select the following:
 - **Primary or Secondary Server:** Identify the server by selecting Primary Server or Secondary Server.
 - **Enable Server:** From the drop-down list, select **Enable** to enable the server or **Disable** to disable the server.
 - **RADIUS Server:** Enter the IPv4 address, IPv6 address, or the host name of the RADIUS server.
 - **Secret:** Shared secret (case sensitive).
 - **NAS IP Address:** The NAS field allows you to select an IP address from the IP addresses of the card.
 - **UDP Port:** The User Datagram Port (UDP) number (standard: 1812).
 - **Time Out (sec):** Type the number of seconds to wait for a response from the authentication server before trying to reconnect.
 - **Retry Number:** Type the number of times to try to reconnect to the authentication server before reporting that the connection failed for one authentication attempt.
6. When you finish selecting parameters for the RADIUS server, click **Save** or **Cancel**.

Edit Parameters for a RADIUS Server

1. Access the Web interface and log in.
2. Under Network and Security, select RADIUS. The Security - RADIUS page displays.
3. In the RADIUS Server panel Name column, click the name of the RADIUS server you want to edit.
4. The RADIUS Settings dialog displays. Change the parameters as needed.
5. When you finish modifying parameters for the RADIUS server, click **Save** or **Cancel**.

Chapter 9 Maintenance and Alarms

This section explains maintenance functions for the Eaton Enclosure Power Distribution Unit (ePDU) G3, including:

- Preventive maintenance
- Equipment disposal
- Replacing the ePDU Network Management and Control (eNMC) module
- Updating Firmware
- Alarms

Preventive Maintenance

For the best preventive maintenance, keep the area around the ePDU clean and dust-free. If the atmosphere is very dusty, clean the outside of the system with a vacuum cleaner. Do not to exceed 60°C (140°F) for best performance.

Equipment Disposal

Contact your local recycling or hazardous waste center for information on proper disposal of the used ePDU.



CAUTION

Do not discard waste electrical or electronic equipment (WEEE) in the trash. For proper disposal, contact your local recycling/reuse or hazardous waste center.

Replacing the ePDU Network Management and Control Module



NOTE

Handle the eNMC module with care. Be aware that there is a risk of electrostatic discharge (ESD). As a preventive measure, wear ESD protection, such as an ESD shoe strap, while replacing the eNMC module. Do not put stress on the connection cable during installation.

A hardware configuration file specific to the ePDU model needs to be uploaded to the new eNMC module so that the eNMC module knows the characteristics of the ePDU model in which it resides (such as what type of input, how many circuit breakers, how many outlets, and how measurements should be displayed).

Typically, the eNMC module in your ePDU is being replaced because it is not working. In this case, you need to get a copy of the ePDU model's hardware configuration file from the Product Model Web site or from another working ePDU of the same model type and configuration. Then, you need to upload the ePDU model-specific hardware description file to the new eNMC module after it is installed.

However, if you are replacing a working eNMC module, the resident ePDU model's hardware description file can be downloaded before you remove the eNMC module to a USB drive or your computer using FTP. Then, you can restore this file to the new eNMC after you install it.

NOTE 1

The eNMC module is hot-swappable. This means outlets will not be affected or change on/off state during the replacement process.



NOTE 2

See "USB Flash Mode Submenu" on page 71 for more information about saving and uploading the user configuration files that store the settings customized by the user, such as the network parameters, outlet names, and threshold values.

Vertical Models Only: To replace the eNMC module (see Figure 95):

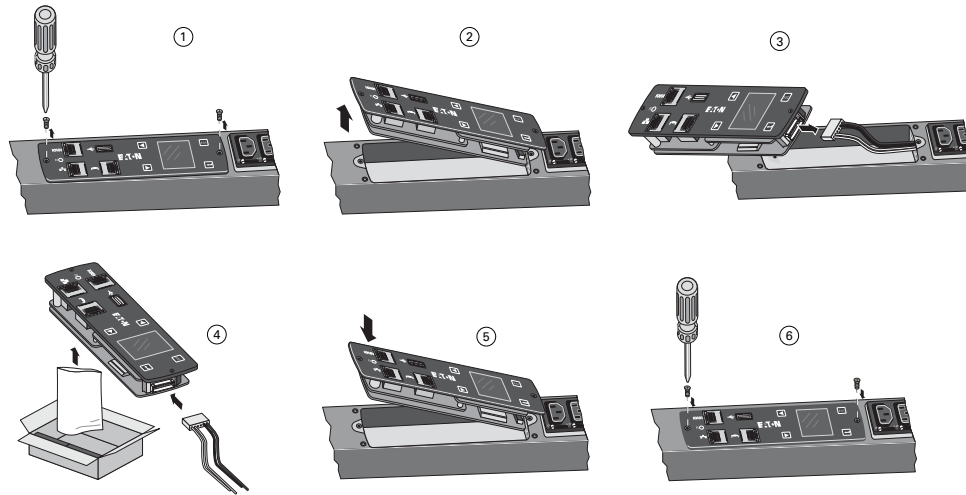

Figure 95. Replacement Procedure

1. Remove the two eNMC module mounting screws.
2. Tilt up one side of the eNMC module and locate the attached cable harness.
3. Disconnect the cable harness and remove the eNMC module.
4. Locate and unwrap the new eNMC module. Connect the cable harness to the new eNMC module.
5. Reinsert the new eNMC module.
6. Install the two eNMC module mounting screws.



NOTE

After the new eNMC module is connected, the “internal communication error” message displays until the configuration file is uploaded to the eNMC module.

7. The new eNMC module will not have the same MAC address as the one you are replacing. Ensure the old MAC address label is discarded and that new MAC address label is firmly adhered to the product.
8. Download the ePDU model’s hardware configuration file using one of the following processes:
 - From the Web (go to Step 9)
 - To the USB with an ePDU with the same configuration (go to Step 15)
9. Go to www.eaton.com/ePDU.
10. If available, click the Sign In button in the upper left corner of the page to sign in (see Figure 96). Return to the ePDU home page. (The Sign In button will not be available if you are already logged in. The button selection will be “Sign Out” instead of “Sign In.”)

Register | Sign In

Figure 96. Sign In/Sign Out Button

11. Enter the part number of your ePDU in the Eaton Product Wizards “ePDU Part Number Search” field. Click **Search**. The Search Results page displays (see Figure 97).

ePDU Search Wizards

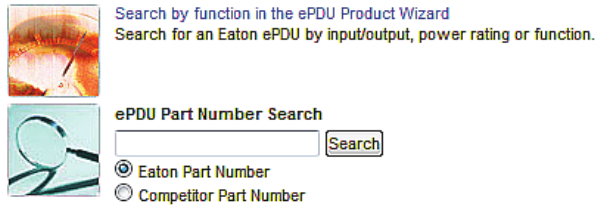

Figure 97. Search Wizard

- On the Search Results page, click the linked part number under the part number column. The Product page for the specified ePDU opens (see Figure 98).

Part Number	Style Number	Function	U Height	Max kW	Plug
EATON METERED INPUT EPDU					
Top Sellers 0-2 week lead time					
EMI100-10	EMI100-10	MI	0U	1.44	5-15P

Figure 98. Search Results

- Copy and save the ePDU model-specific hardware configuration file to your computer using the link near the bottom of the page.



NOTE The link to the configuration file only displays if you are signed in.



IMPORTANT

Be sure that the Configuration number on the unit rating label also appears in the file name of the model-specific ePDU hardware configuration file.

- Go to Step 21.
- Make sure the eNMC module is powered ON. Connect a USB flash drive to a working ePDU.



IMPORTANT

This ePDU must be of the same model type and configuration as the ePDU that houses the eNMC you will replace.

- When the LCD interface pop-up confirms that the USB flash drive is detected, click OK, and press Enter to return to the Main Menu. (If not confirmed within 10 seconds, the pop-up goes away by itself.)
- From the Settings menu, select USB Flash Mode. Press Enter, select yes to confirm, and then press Enter again. The module restarts. (If there is no action within one minute, the eNMC module exits USB Flash Mode. Remove and reinsert the flash drive to access this menu again.)
- Select Save eNMC file to save the ePDU hardware configuration file to the USB drive. The file will save to the eNMC/config/hw path at the USB drive root directory (see Figure 99).

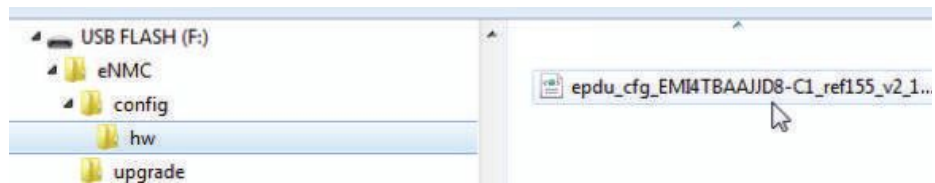

Figure 99. USB Root Directory

19. When the file is saved, click OK to confirm.
20. Disconnect the USB drive from the working ePDU.
21. Upload the ePDU hardware configuration file using one of the following processes:
 - FTP (Step 22)
 - USB (Step 32)

NOTE 1 To perform the eNMC configuration upload with USB, only one hardware configuration file must be stored in the USB key.



NOTE 2 For FTP operation, FTP must be enabled (default setting) in the Web pages (**Network > Security > Global > FTP enable**).

22. Open a DOS command window on a computer that is also connected to network.
23. Change directory (CD) to the location of the XML file.
24. Open an FTP session using the following command:

```
>ftp <IPaddress>
```

where <IPaddress> = the IP address displayed on LCD
25. Type the default login and password ("admin" and "admin").
26. At the command prompt, type the following command:

```
>cd config/hw
```

```
>dir
```
27. If an ePDU hardware configuration file (XML) file already exists, type the following command to delete the file:

```
>delete <config file>
```
28. To upload the ePDU hardware configuration file to the eNMC module, type the following command:

```
>put <config file>
```

where <config file> = the file name to be downloaded to the eNMC module



NOTE Keep the <config file> name exactly as it is downloaded from the website. It must begin with the prefix "epdu_cfg_" or the eNMC module will not recognize it.

29. Type the following command to verify the file has been uploaded:

```
>dir
```
30. Type the following command to quit the FTP session:

```
>quit
```
31. Go to the "Restarting the eNMC Module and Resetting the ePDU" procedure that follows.

32. Make sure the eNMC module is powered ON. Connect the USB flash drive to the ePDU with the new eNMC.
33. When the LCD interface pop-up confirms that the USB flash drive is detected, click OK, then press Enter to return to the Main Menu. (If not confirmed within 10 seconds, the pop-up goes away by itself.)
34. From the LCD Settings menu, select USB Flash Mode. Press Enter, select yes to confirm, and then press Enter again. The module restarts. (If there is no action within one minute, the eNMC module exits USB Flash Mode. Remove and reinsert the USB flash drive to access this menu again.)
35. Select Load eNMC file, then click OK to upload the ePDU hardware configuration file to the eNMC.
36. When the file is successfully loaded, click OK to confirm.
37. Remove the USB flash drive and select Exit.
38. Go to the "Restarting the eNMC Module and Resetting the ePDU" procedure that follows.

Restarting the eNMC Module and Resetting the ePDU

1. Restart the eNMC module using either the reset button on the LCD front panel (see "Restarting the ePDU Network Management and Control (eNMC) module" on page 53), or using a serial or network connection to a terminal emulator or Web interface.
2. Reset the ePDU to factory default settings using one of the following:
 - Web interface "Configure ePDU Network Management and Control Module" on page 121
(**System > Network Management Card Configuration panel > Restore Factory default settings > Yes**)
 - LCD menu "Factory Submenu" on page 81
(**Settings > Factory > Return to Factory Settings > Yes > OK**)



NOTE

Step 1 and Step 2 must be performed or the new configuration will not be properly accepted by the eNMC module. If something doesn't look right afterward, perform Step 2 (reset to defaults) a second time.

After the ePDU hardware configuration file is uploaded and eNMC module is rebooted and reset to factory defaults, the ePDU settings return to default settings and the energy counter restarts from 0. Only the serial number is recovered.

Firmware Upgrade

The firmware upgrade process allows you to maintain the most current firmware by updating the ePDU Network Management and Control (eNMC) module with new or enhanced features and applying periodic bug fixes.

The upgrade file is named **Image<xxx>.bin**. (The <xxx> values will vary for each upgrade.) During the upgrade, the firmware and the Web page are both upgraded to avoid incompatibility between the firmware version and the Web site. Additional validation checks are performed as well.

The new firmware files can be uploaded using either Hypertext Transfer Protocol (HTTP), File Transfer Protocol (FTP), or USB. With all methods, the basic steps are the same:

1. **Upload the Binary File.** This file will be stored in a temporary location in the communications module.
2. **Implement the Firmware.** After the file is loaded, the bootloader will implement the firmware in the eNMC module to upgrade the firmware and refresh the Web pages.

NOTE  Groups of Eaton ePDU G3 models can be configured or updated with new firmware at the same time using Eaton Intelligent Power Manager (IPM). The IPM software is available separately at no cost for up to 10 devices. Refer to the *Eaton Intelligent Power Manager (IPM) User's Guide* for more information.

 **IMPORTANT**

We strongly recommend that you leave only one IPM activated when mass upgrade or mass configuration operations are performed to upgrade eNMC from IPM. You should shut off all paralleled IPM (up to 9) during these operations.

Upgrading Firmware with Hypertext Transfer Protocol

The HTTP upgrade using the Web occurs in two stages:

- Upload the binary file
- Implement the firmware

Uploading the Binary File

To access the Web interface:

1. Ensure that an Ethernet cable is correctly connected between a Windows PC and the Ethernet port on the ePDU. Verify communication.
2. Start up the ePDU and note the IP address displayed on the LCD.
3. Open the Web browser and type the IP address you obtained from the ePDU.
4. When the connection is made, the Authentication dialog displays.
5. Enter a valid user name and password in the authentication dialog box (see Figure 100). Click **Login** to continue or **Cancel** to exit.

NOTE  The default user name is "admin" and the default password is "admin."

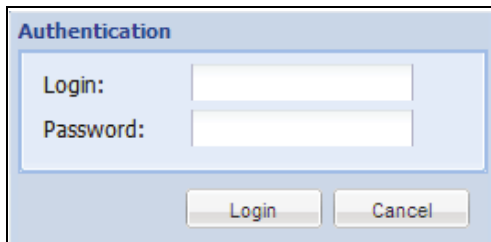

Figure 100. Login Authentication

6. The ePDU Overview page displays.
7. From the menu bar, click Settings and then System. The System Settings page displays in the Main Application window (see Figure 101).
8. In the Network Management Card panel, check **Firmware upgrade enabled** and click **Browse** to find the upgrade file.

Figure 101. System Settings Page

9. From the Open window, select the **Image<xxx>.bin** file, and click **Open**.
10. In the Network Management Card panel, click **Upgrade Network Management Card** to launch the upload. A progress bar shows the progress of the update.

 **CAUTION**

Do not disturb the upgrade until the progress bar shows complete.

11. When finished, a message displays and the communications module restarts automatically. The upgrade takes four to five minutes. When the upgrade completes, refresh the Web pages.

Upgrade the Firmware and Refresh Web Pages

After the binary file is uploaded to the communications module, the final step is an automatic process that upgrades the firmware and refreshes the Web pages.

The communications module reboots and, in Bootloader mode, detects a new available image, checks validity of this image, and launches the upgrade of the firmware and refresh the Web pages. As the upgrade processes, a message box displays with percent completed.

When completed, an upgrade message displays **F/W: 100%**, and the communications module reboots with the new firmware and refreshed Web pages.

Upgrading the Firmware with FTP Protocol



NOTE By default, FTPS protocol is set. Use a dedicated software to upgrade the firmware via FTPS. Select FTP protocol via Web pages and use the FTP command via an MS-DOS console to upgrade the firmware.

The FTP upgrade occurs in two stages:

- Upload the binary file
- Implement the firmware



NOTE The FTP server must be enabled for this procedure. This is an option on the Global Security page of the Web interface.

Uploading the Binary File

To access the Web interface:

1. Ensure that an Ethernet cable is correctly connected between a Windows PC and the Ethernet port on the ePDU. Verify communication.
2. Start up the ePDU and note the IP address displayed on the LCD.
3. Open an MS-DOS command line window and connect to the communications module in FTP mode (see Figure 102):
 - Type **FTP @IP**, where @IP is the previous IP address.
 - Type the user name and password of the SuperUser.
 - Type the **hash** command. This allows you to follow the upload as it progresses.
4. At the **ftp>** command line, use the **put** command with the **Image<xxx>.bin** file to launch the upgrade (see Figure 102).

Upgrading the Firmware with the USB Port

See “Settings Menu” and “USB Flash Mode Submenu” on page 71 for more information of upgrading with the USB.

Active Alarms

The Eaton ePDUs have a rich set of alarms and events to notify you of up-to-date activity and operation status. Both the local ePDU LCD interface and the remote Web interface provide active alarm notifications when alarms become active.

- On the LCD interface, the existing LCD display is replaced by the Active Alarms screen and the backlight is blinking red when an alarm is generated.
- On the Web interface, two active alarm notifications are provided:
 - In the menu hierarchy, the text for Active Alarms is red when alarms are active.
 - In the bottom of the window (the refresh bar), a message displays, “Warning, some alarms fired, please refer to the Active Alarms | Last Refresh: dd/mm/yyyy - hh:hh:ss.” The words “Active Alarms” in the message are a link to the Active Alarms page.

NOTE 1 The alarm and event list is subject to change.



NOTE 2 For LCD interface information, see “Active Alarms Menu” on page 65. For Web interface information, see “Active Alarms” on page 114.

- To clear flashing LCDs and the LED:
 - Press any button on the ePDU or clear the alarm using the Web interface.
- To correct a condition:
 - Define the alarm condition and resolve the condition.
- Self-correcting conditions:
 - Sometimes, the alarm automatically clears when the condition resolves. For example, if a load over current alarm is generated, the alarm is cleared when the current drops 0.1A below the level (alarm hysteresis).

Defining the Alarm or Event Condition

You can derive defining information about the alarm or event from the associated number code. Figure 104 shows the location of the associated number code in the Code column on the Logs page of the Web interface.

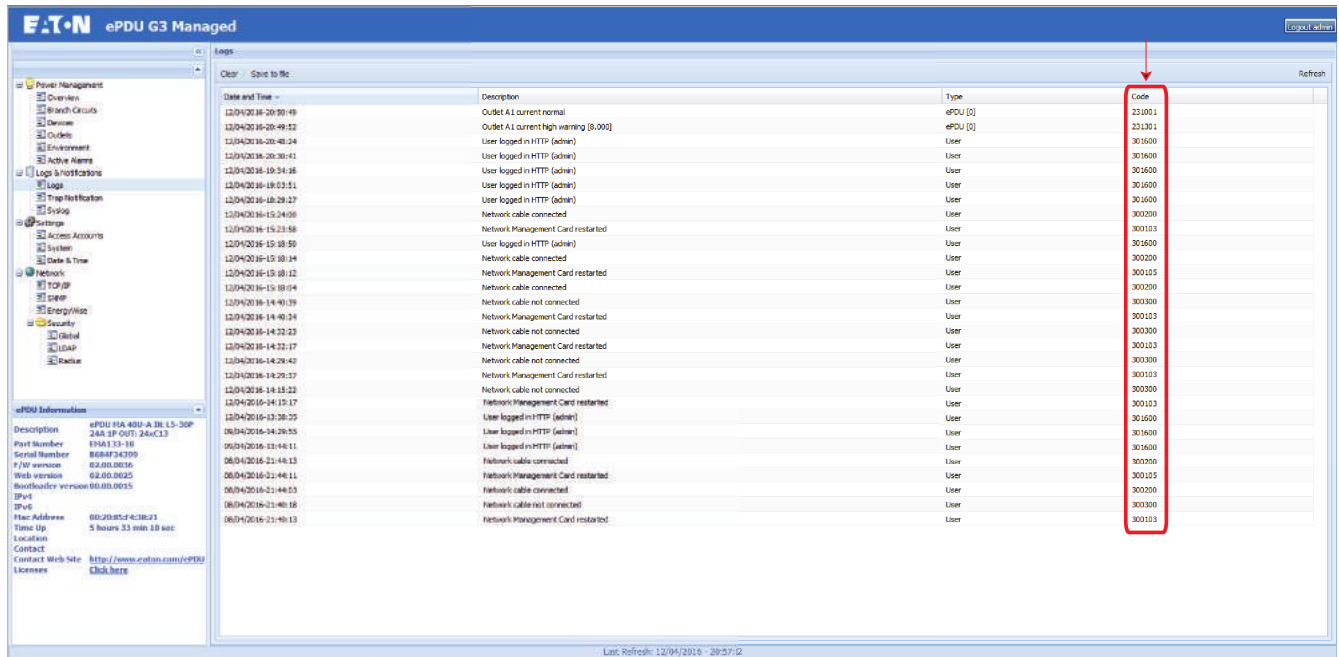

Figure 104. Location of Alarm Code on Web Interface

This number code is a six-digit number. The first digit in the number conveys the source of the alarm or event. The remaining five digits in the number code further identify and define the type of alarm (see Figure 105).

5-Digit Index Code and/or Identification Code:
 For Type 0 and Type 1 = Identification Code (0 to 9999)
 For Type 2 and Type 3 = Identification Code (0 to 999) and Index Code (0 to 99)

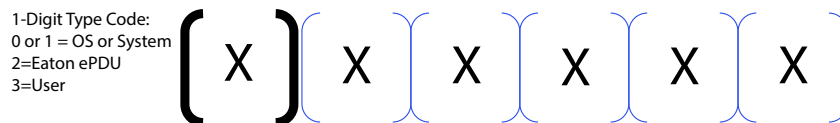

Figure 105. Alarm Code Format

Type Code 0 or 1 (OS or System)



IMPORTANT

For Type Code 0 and Type Code 1, always contact customer support for assistance. These errors are not user-correctable.

The Type Code 0 and Type Code 1 alarms and events are triggered from the OS or the system. Figure 106 provides an example of a Type Code 1 system alarm number code. It only contains an 5-digit identification code (no index code).

Alarm number code 102820: No answer from a CAN device

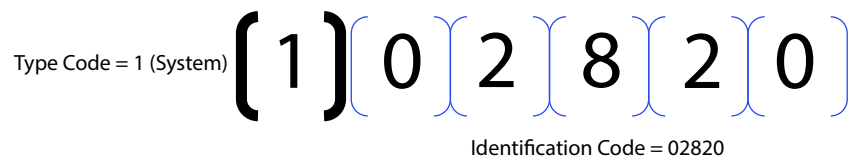

Figure 106. Example Type 1 Code

Table 10 lists OS or System alarms and events.

Table 10. OS or System Alarms and Events

Type Code	Identification Code	Alarm or Event
1	03073	Code unreachable
1	03074	Heap overflow
1	03075	Not enough memory in Heap
1	02817	A command is sent to an unavailable device CAN
1	02818	*Not used
1	02819	Impossible to open a session with a CAN device
1	02820	No answer from a CAN device
1	02821	*Not used
1	02822	The number of CAN devices discovered on CAN bus is too great
1	02823	Command unknown
1	02824	Device CAN Id out of range
1	02825	Time duration of a command is too long
1	02826	Report acquired from CAN device is wrong
1	02827	Report descriptor acquired from CAN device is wrong
1	01281	Mutex not available
1	01282	HID object Id out of range
1	01283	Report empty or not valid
1	01284	Report Id out of range
1	01285	Not enough memory in HEAP
1	01286	Duration of the acquisition of Teridian is too long
1	01282	HID object Id not in list of data saved in EEPROM
1	02561	*Not used
1	02562	*Not used
1	02563	*Not used
1	02564	Wrong data type
1	02565	String too long
1	02566	*Not used
1	02567	*Not used
1	01025	*Not used
1	01026	Semantic error
1	01027	Impossible to open log file
1	01028	Impossible to write data in log file

Table 10. OS or System Alarms and Events (Continued)

Type Code	Identification Code	Alarm or Event
1	01029	Impossible to seek data in log file
1	01030	Impossible to read data in log file
1	01031	Mutex not available
1	01032	*Not used
1	01033	Impossible to clear LOG file
1	03585	Initialization of SSH task failed
1	03076	Error writing in flash memory during an upload
1	03077	End signature of the uploaded file does not match
1	03078	Checksum of the uploaded file does not match
1	03586	Reading of the host key file (or table) failed
1	03587	Listening of SSH socket failed
1	03588	Acceptance of SSH socket failed
1	03589	Break received
1	03590	Max number of SSH connection reached
1	03591	Certificate error
1	03592	*Not used
1	04865	Error reading from the 12C Eeprom
1	04866	Error writing to the 12C Eeprom
1	03841	SNMP bad trap number

Type Code 2 or 3 (ePDU or User)

Type 2 alarms and events are triggered from the ePDU. These alarms and events are primarily threshold crossings when the operation measurement is beyond the threshold value range setting. Type 2 alarms and events also provide the state of optional connected equipment.

Type 3 alarms and events are triggered from user actions.

Figure 107 provides an example of a Type Code 2 ePDU alarm number code.

Number code 211402: Eaton ePDU Critical Overcurrent L2 Phase

**Figure 107. Example Type 2 Code**

Table 11 lists ePDU and User alarms and events.

Table 11. ePDU and User Alarms and Events

Type Code	Identification and Index Code	Alarm or Event	Description
2	201000	Dry Contact 1 Not Active	The signal for Dry Contact 1 is active.
2	201100	Dry Contact 1 Active	The signal for Dry Contact 1 is not active.
2	202000	Dry Contact 1 Open	Dry Contact 1 is open.
2	202100	Dry Contact 1 Closed	Dry Contact 1 is closed.
2	203000	Dry Contact 2 Not Active	The signal for Dry Contact 2 is active.
2	203100	Dry Contact 2 Active	The signal for Dry Contact 2 is not active.
2	204000	Dry Contact 2 Open	Dry Contact 2 is open.
2	204100	Dry Contact 2 Closed	Dry Contact 2 is closed.
2	205000	Sensor Probe Communication Failure Cleared	Sensor Probe communication failure is cleared
2	205100	Sensor Probe Communication Failure	Sensor probe communication failure detected
2	208000	Sensor Probe Not Connected	Sensor probe not connected since firmware startup
2	208100	Sensor Probe Connected	Sensor probe connected at least once since firmware startup
2	206000	Humidity No Threshold	No humidity threshold has been triggered.
2	206100	Humidity Warning Low Threshold	The humidity level reading is less than the value configured as the low humidity warning threshold.
2	206200	Humidity Critical Low Threshold	The humidity level reading is less than the value configured as the low humidity critical threshold.
2	206300	Humidity Warning High Threshold	The humidity level reading is greater than the value configured as the high humidity warning threshold.
2	206400	Humidity Critical High Threshold	The humidity level reading is greater than the value configured as the high humidity critical threshold.
2	207000	Temperature No Threshold	No temperature threshold has been triggered.
2	207100	Temperature Warning Low Threshold	The temperature level reading is less than the value configured as the low temperature warning threshold.
2	207200	Temperature Critical Low Threshold	The temperature level reading is less than the value configured as the low temperature critical threshold.
2	207300	Temperature Warning High Threshold	The temperature level reading is greater than the value configured as the high temperature warning threshold.
2	207400	ePDU Temperature Critical High Threshold	The temperature level reading is greater than the value configured as the high temperature critical threshold.
2	211000	ePDU Input 1 Current No Threshold	No section current threshold has been triggered.
2	211100	ePDU Input 1 Low Current Warning	The current amperage (A) reading for the specified section is less than the value configured as the low current warning alarm threshold.
2	211200	ePDU Input 1 Low Current Critical	The current amperage (A) reading for the specified section is less than the value configured as the low current critical alarm threshold.
2	211300	ePDU Input 1 Over Current Warning	The specified section current amperage (A) reading is greater than the value configured as the over current warning threshold.

Table 11. ePDU and User Alarms and Events (Continued)

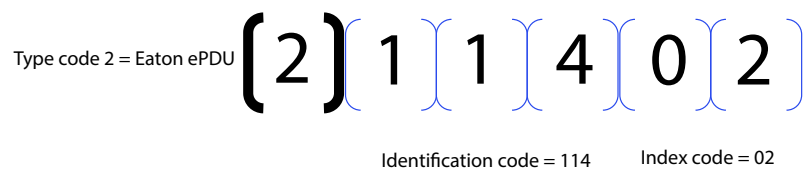
Type Code	Identification and Index Code	Alarm or Event	Description
2	211400	ePDU Input 1 Over Current Critical	The specified section current amperage (A) reading is greater than the value configured as the over current critical alarm threshold.
2	212000	ePDU Input 1 Voltage No Threshold	No section voltage threshold has been triggered.
2	212100	ePDU Input 1 Low Voltage Warning	The specified section voltage reading is less than the value configured as the low voltage warning threshold.
2	212200	ePDU Input 1 Low Voltage Critical	The specified section voltage reading is less than the value configured as the low voltage critical threshold.
2	212300	ePDU Input 1 Over Voltage Warning	The specified section voltage reading is greater than the value configured as the over voltage warning threshold.
2	212400	ePDU Input 1 Over Voltage Critical	The specified section voltage reading is greater than the value configured as the over voltage critical threshold.
2	213000	ePDU Input 1 Frequency OK	Utility frequency is within the +/- 3 Hz of Nominal frequency.
2	213100	ePDU Input 1 Frequency Out of Range	Utility frequency greater or less than +/- 3 Hz of Nominal frequency.
2	214000	ePDU Input 2 Current No Threshold	No section current threshold has been triggered.
2	214100	ePDU Input 2 Low Current Warning	The current amperage (A) reading for the specified section is less than the value configured as the low current warning alarm threshold.
2	214200	ePDU Input 2 Low Current Critical	The current amperage (A) reading for the specified section is less than the value configured as the low current critical alarm threshold.
2	214300	ePDU Input 2 High Current Warning	The specified section current amperage (A) reading is greater than the value configured as the over current warning threshold.
2	214400	ePDU Input 2 High Current Critical	The specified section current amperage (A) reading is greater than the value configured as the over current critical alarm threshold.
2	215000	ePDU Input 2 Voltage No Threshold	No section voltage threshold has been triggered.
2	215100	ePDU Input 2 Low Voltage Warning	The specified section voltage reading is less than the value configured as the low voltage warning threshold.
2	215200	ePDU Input 2 Low Voltage Critical	The specified section voltage reading is less than the value configured as the low voltage critical threshold.
2	215300	ePDU Input 2 High Voltage Warning	The specified section voltage reading is greater than the value configured as the over voltage warning threshold.
2	215400	ePDU Input 2 High Voltage Critical	The specified section voltage reading is greater than the value configured as the over voltage critical threshold.
2	216000	ePDU Input 2 Frequency OK	The frequency is not out of range.
2	216100	ePDU Input 2 Frequency out of +/- 3 Hz tolerance	The frequency is out of range.

Table 11. ePDU and User Alarms and Events (Continued)

Type Code	Identification and Index Code	Alarm or Event	Description
2	221000	ePDU Gang Phase Input Current No Threshold	No section current threshold has been triggered.
2	221100	ePDU Gang Phase Low Current Warning	The current amperage (A) reading for the specified section is less than the value configured as the low current warning alarm threshold.
2	221200	ePDU Gang Phase Low Current Critical	The current amperage (A) reading for the specified section is less than the value configured as the low current critical alarm threshold.
2	221300	ePDU Gang Phase Over Current Warning	The specified section current amperage (A) reading is greater than the value configured as the over current warning threshold.
2	221400	ePDU Gang Phase Over Current Critical	The specified section input current amperage (A) reading is greater than the value configured as the over current critical alarm threshold.
2	222000	ePDU Gang Phase Voltage No Threshold	No section voltage threshold has been triggered.
2	222100	ePDU Gang Phase Low Voltage Warning	The specified section voltage reading is less than the value configured as the low voltage warning threshold.
2	222200	ePDU Gang Phase Low Voltage Critical	The specified section voltage reading is less than the value configured as the low voltage critical threshold.
2	222300	ePDU Gang Phase Over Voltage Warning	The specified section voltage reading is less than the value configured as the over voltage warning threshold.
2	222400	ePDU Gang Phase Over Voltage Critical	The specified section voltage reading is less than the value configured as the over voltage critical threshold.
2	223000	ePDU Gang Not Alarmed	No alarm has been triggered.
2	223100	ePDU Gang Alarmed	An alarm has been triggered.
2	241000	Communication OK	No communication failure detected on Teridian RS-485 bus
2	241100	Communication Lost	Communication failure detected on Teridian RS-485 bus
2	251000	Daisy Chain Communication OK	No communication failure detected on Daisy Chain
2	251100	Daisy Chain Communication Alarmed	Communication failure detected on Daisy Chain
2	231000	ePDU Outlet Current No Threshold	No outlet current threshold has been triggered.
2	231100	ePDU Outlet Low Over Current Warning	The current amperage (A) reading for the specified outlet is less than the value configured as the low current warning alarm threshold.
2	231200	ePDU Outlet Low Over Current Critical	The current amperage (A) reading for the specified outlet is less than the value configured as the low current critical alarm threshold.
2	231300	ePDU Outlet High Over Current Warning	The specified outlet current amperage (A) reading is greater than the value configured as the over current warning threshold.
2	231400	ePDU Outlet High Over Current Critical	The specified outlet input current amperage (A) reading is greater than the value configured as the over current critical alarm threshold.

Table 11. ePDU and User Alarms and Events (Continued)

Type Code	Identification and Index Code	Alarm or Event	Description
2	232000	ePDU Outlet switch off	The specified outlet is Off.
2	232100	ePDU Outlet switch on	The specified outlet is On.
3	300100	Communication module restarted	The communication module has been restarted by the user.
3	300200	Ethernet cable connected	The Ethernet cable is connected.
3	300300	Ethernet cable not connected	The Ethernet cable is not connected.
3	300400	Factory reset requested by <interface>	A factory reset has been requested through the specified user interface.
3	300500	Ethernet card restart requested by <interface>	An Ethernet card restart has been requested through the specified user interface.
3	300600	Switch to bootloader mode for upgrade by <interface>	A Switch to bootloader mode for upgrade has been requested through the specified user interface.
3	300700	ePDU & System Log cleared	The ePDU & System Log have been cleared.
3	300800	Daisy Chain device does not answer	The Daisy Chain device does not answer.
3	300900	Time changed	The time was changed by the user.
3	301000	Daisy chain device connected	The daisy chain device is connected.
3	301100	Daisy chain device disconnected	The daisy chain device is disconnected.
3	301200	Upgrade request by user	An upgrade was requested by the user.
3	301300	Sensor connected	The sensor was connected.
3	301400	Sensor disconnected	The sensor was disconnected.
3	301500	Send mail test by user	The user sent a mail test.
3	301600	User logged in	The specified user logged in by the specified protocol.
3	301700	User logged out	The specified user logged out by the specified protocol.
3	301800	User logged in FTP	The specified user logged in by FTP.
3	301900	User logged out FTP	The specified user logged out by FTP.
3	302000	User failed to log FTP	The specified user failed to log by FTP.
3	302100	Ethernet card restart in USB mode	The Ethernet card has been restarted in USB mode.
3	302200	Network settings file uploaded from USB	The network settings file has been uploaded from the USB.
3	302300	eNMC module settings file uploaded from USB	The eNMC module settings file has been uploaded from the USB.
3	302400	ePDU settings file uploaded from USB	The ePDU settings file has been uploaded from the USB.

Chapter 10 Service and Support

If you have any questions or problems with the Eaton Enclosure Power Distribution Unit (ePDU) G3, call your **Local Distributor** or the **Help Desk** at one of the following telephone numbers and ask for an ePDU technical representative:

United States: **1-800-356-5737**
 Canada: **1-800-461-9166 ext 260**
 All other countries: **Call your local service representative**

Please have the following information ready when you call for service:

- Model number
- Serial number
- Date of failure or problem
- Symptoms of failure or problem
- Customer return address and contact information

Table 12 provides the Eaton catalog part number for ordering optional and spare parts for the ePDU. Contact your local service representative for more information.

Table 12. Optional and Spare Parts

Eaton Catalog Number	Optional or Spare Part	Americas/APAC Market	EMEA/APAC Market	Description
EMP001	Optional	•	•	Eaton Environmental Monitoring Probe
SPK012	Spare Part	•	—	ePDU G3 Installation Spare Pack (Americas)
SPK013	Spare Part	•	—	ePDU G3 Network Spare Pack (Americas)
SPK021	Spare Part	•	—	ePDU G3 1U/2U Installation Spare Pack (Americas)
SPK024	Spare Part	•	—	ePDU G3 1U Mounting Bracket (Service)
SPK025	Spare Part	•	—	ePDU G3 2U Mounting Bracket (Service)
SUB-HRDW-3007	Spare Part	•	—	eNMC Module Replacement Pack (Americas)
SUB-HRDWARE-073	Optional	•	—	ePDU G3 Mounting Bracket for Cisco Racks (Individual Shipment)
SUB-HRDWARE-076	Optional	•	—	ePDU G3 Mounting Bracket for Cisco Racks (Multiple Bulk Shipment)
SUB-HRDWARE-078	Optional	•	—	ePDU G3 Custom Recessed Mounting for Rittal® Racks
SUB-HRDWARE-079	Optional	•	—	ePDU G3 1U Side-Pocket Mounting Bracket Kit for Cisco R-Series Racks
KSP017	Spare Part	—	•	ePDU G3 eNMC Module Replacement Pack (EMEA)
KSP027	Spare Part	—	•	ePDU G3 1U/2U eNMC Module Replacement Pack (EMEA)
KSP020	Spare Part	—	•	ePDU G3 Installation and Network Spare Pack (EMEA)

Chapter 11 Warranty

Two-Year Limited Warranty (USA and Canada)

Eaton Enclosure Power Distribution Units (ePDUs)

WARRANTOR: The warrantor for the limited warranties set forth herein is Eaton (“Company”).

RACKMOUNTED LIMITED WARRANTY: This limited warranty (this “Warranty”) applies only to the original End-user (the “End-user”) of any Eaton Rackmounted Power Distribution Units (the “Product”) purchased on or after July 1, 2012, and cannot be transferred. This Warranty applies even in the event that the Product is initially sold by Company for resale to an End-user.

LIMITED WARRANTY PERIOD: The period covered by this Warranty for Product installed [and currently located] in the fifty (50) United States, the District of Columbia and Canada is twenty-four (24) months from the date of purchase, or thirty (30) months from the date of shipment. For units that are registered online at www.eaton.com/PQ/Register, the warranty is extended to thirty-six (36) months from the date of purchase, or fortytwo (42) months from the date of shipment.

WHAT THIS LIMITED WARRANTY COVERS: The warrantor warrants that the Product (the “Warranted Item”) is free from defects in material and workmanship. If, in the opinion of Company, a Warranted Item is defective and the defect is within the terms of this Warranty, Company’s sole obligation will be to repair or replace such defective Warranted Item (including by providing service, parts and labor, as applicable), at the option of Company.

PROCEDURES FOR REPAIR OR REPLACEMENT OF WARRANTED ITEMS:

Standard Product: Defined as ePDU product with the product number sequence PWxxxxxxxx or eXXXXX, (whereas x can be any value). The Warranted item will be repaired or replaced by the Company.

Custom Product: Defined as ePDU product with any product number sequence that does not equal a standard product as noted above. The Warranted item will be repaired at a Company site or such other location as determined by Company.

If the Warranted Item is to be replaced by Company, and the End-user supplies a credit card number or purchase order for the value of the replacement Product, Company will use commercially reasonable business efforts to ship (via standard ground shipment and at no cost to the End-user) the replacement Warranted Item to the End-user within one (1) business day after Company receives notice of the warranty claim. In such case, the End-user must return (at Company’s expense) the defective Warranted Item to Company in the same packaging as the replacement Warranted Item received by the End-user or as otherwise instructed by Company. If Company does not receive the defective Warranted Item, Company will either charge the End-user’s credit card, or send the End-user an invoice (which the End-user agrees to pay), for the value of the replacement Product.

If the Warranted Item is to be replaced by Company, but the End-user is unwilling or unable to supply a credit card number or purchase order for the value of the replacement Product, Company will use commercially reasonable business efforts to ship (via standard ground shipment and at no cost to the End-user) the replacement Warranted Item to the End-user within one (1) business day after Company receives the defective Product from the End-user.

In any case, Company will provide shipping instructions and will pay its designated carrier for all shipping charges for return of defective equipment and replacement of Warranted Items. Any returned Warranted Item or parts that are replaced may be new or reconditioned. All Warranted Items returned to Company and all parts replaced by Company shall become the property of Company.

WHAT THIS LIMITED WARRANTY DOES NOT COVER: This Warranty does not cover any defects or damages caused by: (a) failure to properly store the Product before installation; (b) shipping and delivery of the Product if shipping is FOB Factory; (c) neglect, accident, abuse, misuse, misapplication or incorrect installation; (d) repair or alteration not authorized in writing by Company personnel or performed by an authorized Company Customer Service Engineer or Agent; (e) improper testing, operation, maintenance, adjustment or modification of any kind not authorized in writing by Company personnel or performed by an authorized Company Customer Service Engineer or Agent; or (f) use of the Product under other than normal operating conditions or in a manner inconsistent with the Product's labels or instructions.

This Warranty is not valid if the Product's serial numbers have been removed or are illegible. Any Warranted Items repaired or replaced pursuant to this Warranty will be warranted for the remaining portion of the original Warranty subject to all the terms thereof.

Company shall not be responsible for any charges for testing, checking, removal or installation of Warranted Items.

COMPANY DOES NOT WARRANT EQUIPMENT NOT MANUFACTURED BY COMPANY. IF PERMITTED BY THE APPLICABLE MANUFACTURER, COMPANY SHALL PASS THROUGH SUCH MANUFACTURER'S WARRANTIES TO END-USER.

COMPANY DOES NOT WARRANT SOFTWARE (IF APPLICABLE TO THE PRODUCT), INCLUDING SOFTWARE EMBEDDED IN PRODUCTS, THAT IS NOT CREATED BY COMPANY. WITHOUT LIMITING THE FOREGOING, COMPANY SPECIFICALLY DOES NOT WARRANT SOFTWARE (SUCH AS LINUX) THAT WAS CREATED USING AN "OPEN SOURCE" MODEL OR IS DISTRIBUTED PURSUANT TO AN OPEN SOURCE LICENSE.

THIS WARRANTY IS THE SOLE AND EXCLUSIVE WARRANTY OFFERED BY COMPANY WITH RESPECT TO THE PRODUCTS AND SERVICES AND, EXCEPT FOR SUCH FOREGOING WARRANTY COMPANY DISCLAIMS ALL OTHER WARRANTIES INCLUDING BUT NOT LIMITED TO ANY IMPLIED WARRANTIES OF MERCHANTABILITY, TITLE, NON-INFRINGEMENT AND FITNESS FOR A PARTICULAR PURPOSE. CORRECTION OF NONCONFORMITIES IN THE MANNER AND FOR THE PERIOD OF TIME PROVIDED ABOVE SHALL CONSTITUTE COMPANY'S SOLE LIABILITY AND ENDUSER'S EXCLUSIVE REMEDY FOR FAILURE OF COMPANY TO MEET ITS WARRANTY OBLIGATIONS, WHETHER CLAIMS OF THE END-USER ARE BASED IN CONTRACT, IN TORT (INCLUDING NEGLIGENCE OR STRICT LIABILITY), OR OTHERWISE.

LIMITATION OF LIABILITY: The remedies of the End-user set forth herein are exclusive and are the sole remedies for any failure of Company to comply with its obligations hereunder. In no event shall Company be liable in contract, in tort (including negligence or strict liability) or otherwise for damage to property or equipment other than the Products, including loss of profits or revenue, loss of use of Products, loss of data, cost of capital, claims of customers of the End-user or any special, indirect, incidental or consequential damages whatsoever. The total cumulative liability of Company hereunder whether the claims are based in contract (including indemnity), in tort (including negligence or strict liability) or otherwise, shall not exceed the price of the Product on which such liability is based.

Company shall not be responsible for failure to provide service or parts due to causes beyond Company's reasonable control.

END-USER'S OBLIGATIONS: In order to receive the benefits of this Warranty, the End-user must use the Product in a normal way; follow the Product's user's guide; and protect against further damage to the Product if there is a covered defect.

OTHER LIMITATIONS: Company's obligations under this Warranty are expressly conditioned upon receipt by Company of all payments due to it (including interest charges, if any). During such time as Company has not received payment of any amount due to it for the Product, in accordance with the contract terms under which the Product is sold, Company shall have no obligation under this Warranty. Also during such time, the period of this Warranty shall continue to run and the expiration of this Warranty shall not be extended upon payment of any overdue or unpaid amounts.

COSTS NOT RELATED TO WARRANTY: The End-user shall be invoiced for, and shall pay for, all services not expressly provided for by the terms of this Warranty, including without limitation, site calls involving an inspection that determines no corrective maintenance is required. Any costs for replacement equipment, installation, materials, freight charges, travel expenses or labor of Company representatives outside the terms of this Warranty will be borne by the End-user.

OBTAINING WARRANTY SERVICE: In the USA, call the Customer Reliability Center 7x24 at 800.356.5737. Outside of the USA, contact your local Eaton product sales or service representative, or call the Customer Reliability Center in the USA at 919.845.3683. For comments or questions about this Warranty, write to the Customer Quality Representative, 8609 Six Forks Road, Raleigh, North Carolina 27615 USA.